



E-LOADER III



User Manual

©2022 ELATION PROFESSIONAL all rights reserved. Information, specifications, diagrams, images, and instructions herein are subject to change without notice. ELATION PROFESSIONAL logo and identifying product names and numbers herein are trademarks of ELATION PROFESSIONAL. Copyright protection claimed includes all forms and matters of copyrightable materials and information now allowed by statutory or judicial law or hereinafter granted. Product names used in this document may be trademarks or registered trademarks of their respective companies and are hereby acknowledged. All non-ELATION brands and product names are trademarks or registered trademarks of their respective companies.

ELATION PROFESSIONAL and all affiliated companies hereby disclaim any and all liabilities for property, equipment, building, and electrical damages, injuries to any persons, and direct or indirect economic loss associated with the use or reliance of any information contained within this document, and/or as a result of the improper, unsafe, insufficient and negligent assembly, installation, rigging, and operation of this product.

Elation Professional USA | 6122 S. Eastern Ave. | Los Angeles, CA. 90040
323-582-3322 | 323-832-9142 fax | www.elationlighting.com | info@elationlighting.com

Elation Professional B.V. | Junostraat 2 | 6468 EW Kerkrade, The Netherlands
+31 45 546 85 66 | +31 45 546 85 96 fax | www.elationlighting.eu | info@elationlighting.eu

Elation Professional Mexico | AV Santa Ana 30 | Parque Industrial Lerma, Lerma, Mexico
52000 | +52 (728) 282-7070

ELATION CUSTOMER SUPPORT

Contact ELATION Service for any product related service and support needs. Also visit forums.elationlighting.com with questions, comments or suggestions.

ELATION SERVICE USA - Monday - Friday 8:00am to 4:30pm PST
323-582-3322 | Fax 323-832-9142 | support@elationlighting.com

ELATION SERVICE EUROPE - Monday - Friday 08:30 to 17:00 CET
+31 45 546 85 63 | Fax +31 45 546 85 96 | support@elationlighting.eu

REPLACEMENT PARTS please visit parts.elationlighting.com



DOCUMENT VERSION

Due to additional product features and/or enhancements, an updated version of this document may be available online. Please scan the QR Code with your mobile device or visit www.elationlighting.com for the latest revision/update of this manual, before installation and/or programming.

Date	Document Version	Software Version	DMX Channel Mode	Notes
04/12/19	1.0	N/A	Not Applicable	Initial Release
07/15/21	2.0	N/A	Not Applicable	Updated Document Formatting
01/04/22	3.0	N/A	Not Applicable	Updated Operation section
09/22/22	4.0	N/A	Not Applicable	Updated Operation with clearer images

CONTENTS

General Information FCC Statement	4
Limited Warranty (USA Only)	5
Safety Guidelines	6
Overview	7
Operation	8
Recharging Battery	12
Specifications	13
Optional Components & Accessories	14

GENERAL INFORMATION

INTRODUCTION

Please read and understand the instructions in this manual carefully and thoroughly before attempting to operate this device. These instructions contain important safety and use information.

UNPACKING

Every device has been thoroughly tested and has been shipped in perfect operating condition. Carefully check the shipping carton for damage that may have occurred during shipping. If the carton is damaged, carefully inspect the device for damage, and be sure all accessories necessary to install and operate the device have arrived intact. In the event that damage has been found or parts are missing, please contact our customer support team for further instructions. Please do not return this device to your dealer without first contacting customer support. Please do not discard the shipping carton in the trash. Please recycle whenever possible.



IMPORTANT NOTICE!

THERE ARE NO USER SERVICEABLE PARTS INSIDE THIS UNIT. DO NOT ATTEMPT ANY REPAIRS YOURSELF, AS DOING SO WILL VOID YOUR MANUFACTURER'S WARRANTY. DAMAGES RESULTING FROM MODIFICATIONS TO THIS FIXTURE AND/OR THE DISREGARD OF SAFETY INSTRUCTIONS AND GUIDELINES IN THIS MANUAL VOID THE MANUFACTURER'S WARRANTY AND ARE NOT SUBJECT TO ANY WARRANTY CLAIMS AND/OR REPAIRS.

FCC STATEMENT

This device complies with Part 15 of the FCC Rules. Operation is subject to the following two conditions: (1) this device may not cause harmful interference, and (2) this device must accept any interference received, including interference that may cause undesired operation.

FCC RADIO FREQUENCY INTERFERENCE WARNINGS & INSTRUCTIONS

This product has been tested and found to comply with the limits as per Part 15 of the FCC Rules. These limits are designed to provide reasonable protection against harmful interference in a residential installation. This device uses and can radiate radio frequency energy and, if not installed and used in accordance with the included instructions, may cause harmful interference to radio communications. However, there is no guarantee that interference will not occur in a particular installation. If this device does cause harmful interference to radio or television reception, which can be determined by turning the device off and on, the user is encouraged to try to correct the interference by one or more of the following methods:

- Reorient or relocate the device.
- Increase the separation between the device and the receiver.
- Connect the device and the affected radio receiver to electrical outlets on different circuits.
- Consult the dealer or an experienced radio/TV technician for help.



LIMITED WARRANTY (USA ONLY)

1. Elation Professional hereby warrants, to the original purchaser, Elation Professional products to be free of manufacturing defects in material and workmanship for a period of two years (730 days), and Elation Professional product rechargeable batteries to be free of manufacturing defects in material and workmanship for a period of six months (180 days), from the original date of purchase. This warranty excludes discharge lamps and all product accessories. This warranty shall be valid only if the product is purchased within the United States of America, including possessions and territories. It is the owner's responsibility to establish the date and place of purchase by acceptable evidence, at the time service is sought.
2. For warranty service, send the product only to the Elation Professional factory. All shipping charges must be pre-paid. If the requested repairs or service (including parts replacement) are within the terms of this warranty, Elation Professional will pay return shipping charges only to a designated point within the United States. If any product is sent, it must be shipped in its original package and packaging material. No accessories should be shipped with the product. If any accessories are shipped with the product, Elation Professional shall have no liability what so ever for loss and/or or damage to any such accessories, nor for the safe return thereof.
3. This warranty is void if the product serial number and/or labels are altered or removed; if the product is modified in any manner which Elation Professional concludes, after inspection, affects the reliability of the product; if the product has been repaired or serviced by anyone other than the Elation Professional factory unless prior written authorization was issued to purchaser by Elation Professional; if the product is damaged because not properly maintained as set forth in the product instructions, guidelines and/or user manual.
4. This is not a service contract, and this warranty does not include any maintenance, cleaning or periodic check-up. During the periods as specified above, Elation Professional will replace defective parts at its expense, and will absorb all expenses for warranty service and repair labor by reason of defects in material or workmanship. The sole responsibility of Elation Professional under this warranty shall be limited to the repair of the product, or replacement thereof, including parts, at the sole discretion of Elation Professional. All products covered by this warranty were manufactured after January 1, 1990, and bare identifying marks to that effect.
5. Elation Professional reserves the right to make changes in design and/or performance improvements upon its products without any obligation to include these changes in any products theretofore manufactured.
6. No warranty, whether expressed or implied, is given or made with respect to any accessory supplied with the products described above. Except to the extent prohibited by applicable law, all implied warranties made by Elation Professional in connection with this product, including warranties of merchantability or fitness, are limited in duration to the warranty periods set forth above. And no warranties, whether expressed or implied, including warranties of merchantability or fitness, shall apply to this product after said periods have expired. The consumer's and/or dealer's sole remedy shall be such repair or replacement as is expressly provided above; and under no circumstances shall Elation Professional be liable for any loss and/or damage, direct and/or consequential, arising out of the use of, and/or the inability to use, this product.
7. This warranty is the only written warranty applicable to Elation Professional products and supersedes all prior warranties and written descriptions of warranty terms and conditions heretofore published.

WARRANTY RETURNS

All returned service items whether under warranty or not, must be freight pre-paid and accompany a return authorization (R.A.) number. The R.A. number must be clearly written on the outside of the return package. A brief description of the problem as well as the R.A. number must also be written down on a piece of paper and included in the shipping container. If the unit is under warranty, you must provide a copy of your proof of purchase invoice. Items returned without a R.A. number clearly marked on the outside of the package will be refused and returned at customer's expense. You may obtain a R.A. number by contacting customer support.

SAFETY GUIDELINES

This device is a sophisticated piece of electronic equipment. To guarantee smooth operation, it is important to follow all instructions and guidelines in this manual. The manufacturer of this device is not responsible for injury and/or damages resulting from the misuse of this device due to the disregard of the information printed in this manual. Only qualified and/or certified personnel should use this device. Any modifications to the device will void the original manufacturer's warranty and increase the risk of damage and/or personal injury. DO NOT shake device, and avoid brute force when using.



**FOR USE IN INDOOR OR DRY LOCATIONS ONLY!
DO NOT EXPOSE DEVICE TO RAIN AND/OR MOISTURE!
KEEP FLAMMABLE MATERIALS AWAY FROM DEVICE!**

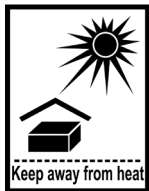

**DO NOT EXPOSE DEVICE TO HEAT OR FIRE!
DO NOT EXPOSE DEVICE TO FLAMMABLE MATERIALS!**



**DO NOT EXPOSE DEVICE TO HIGH HUMIDITY!
DO NOT EXPOSE DEVICE TO EXTREME VIBRATIONS!
DO NOT REMOVE EXTERNAL COVER/HOUSING!
DO NOT PLUG DEVICE INTO A DIMMER PACK!**



**DO NOT USE DEVICE IF THE BATTERY IS DAMAGED, DEFORMED, OR HAS AN ODOR!
DO NOT DISASSEMBLE THE BATTERY!
DISPOSE OF BATTERY PROPERLY ACCORDING TO LOCAL, STATE, AND COUNTRY REGULATIONS!**

OVERVIEW

The E-LOADER III is a battery powered hand held software uploader device used to update Elation compatible lighting fixtures. Easily upload a software update to an Elation lighting fixture by connecting the E-LOADER III to the fixture using a 3pin DMX cable. Elation software updates (not included) are stored on a MICRO SD card (included) and inserted into the uploader. E-LOADER III features an LCD display, 6 button control panel, a MICRO SD card slot, a 3pin XLR DMX OUT, USB cable, and a blank MICRO SD card. Please contact Elation Service for details about available Elation fixture software updates.

BOX CONTENTS:

- Battery
- USB Cable
- USB AC Adapter
- MICRO SD Card
- USB to MICRO SD Card Adapter



1." DMX OUT: 3pin XLR DMX output signal



2." Battery Compartment Cover

3." LCD Display

4." MODE/ESC button

5." UP button

6." LEFT button

7." RIGHT button

8." ENTER button

9." DOWN button



10."Power switch

11."Micro SD Slot

12."Power supply



OPERATION

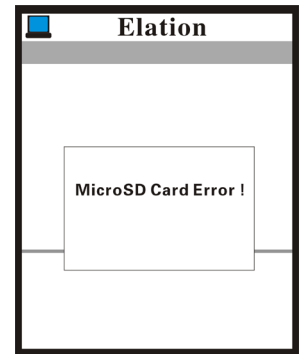

1. With the software update stored on the MICRO SD card, insert the SD card into the slot located at the bottom of the E-Loader III.
2. Connect the signal output cable to the fixture that is going to be updated.
3. Power up the fixture, and then power up the E-Loader III within 10-seconds of powering up the fixture.
4. If the SD card has not been inserted, the screen displays the message, **"MicroSD Card Error!"**

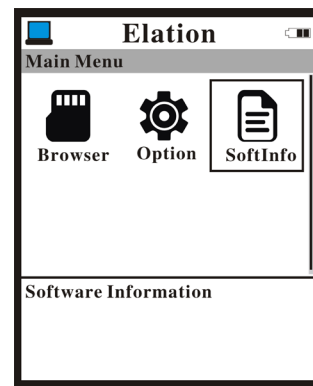
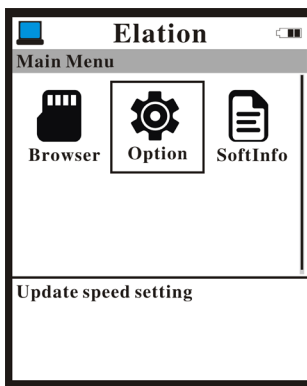
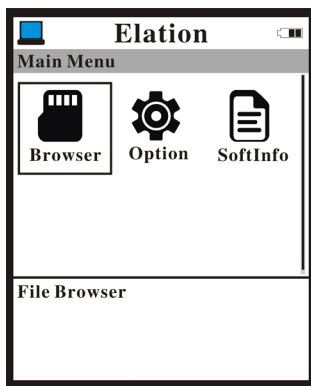

5. Press MODE/ESC to enter SD card menu, then press LEFT or RIGHT to scroll through Browser, Option, or Soft Info (screens shown above), and press ENTER to make your selection.



OPERATION

BROWSER

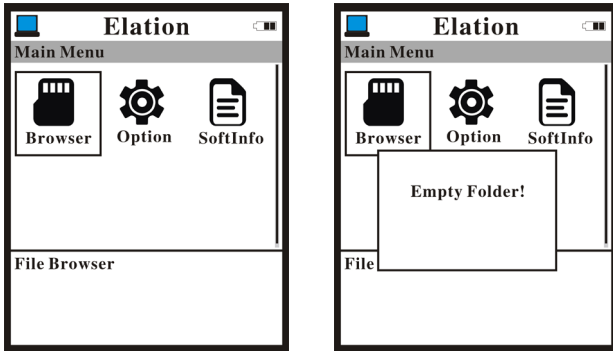

Note that out of the box, the MicroSD card is blank. Make sure the MicroSD is inserted, then select Browser and press ENTER. The message "Empty Folder!" will be displayed.

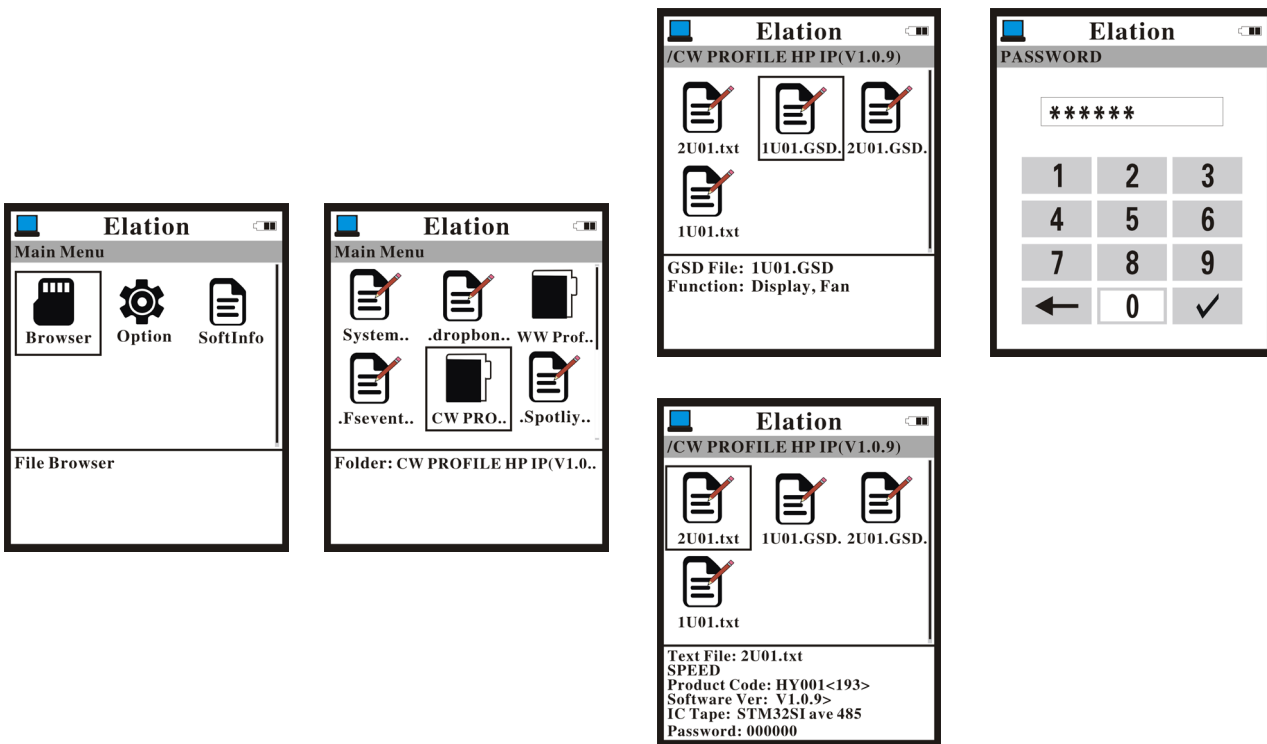

In the Browser menus, select the fixture folder to be updated and Press ENTER. Please note that all non-fixture files displayed here are harmless corrupted files and will not affect the software upload. With the folder selected, the GSD and TXT files will display on the screen. Regardless of file type, the function of the file will appear on the lower left of the screen (display is limited to 5 lines). Select the GSD file you want to upload. Press ENTER. Key in the password; the default password is "000000". (The TXT files are non-functional and exist purely for information purposes)

OPERATION

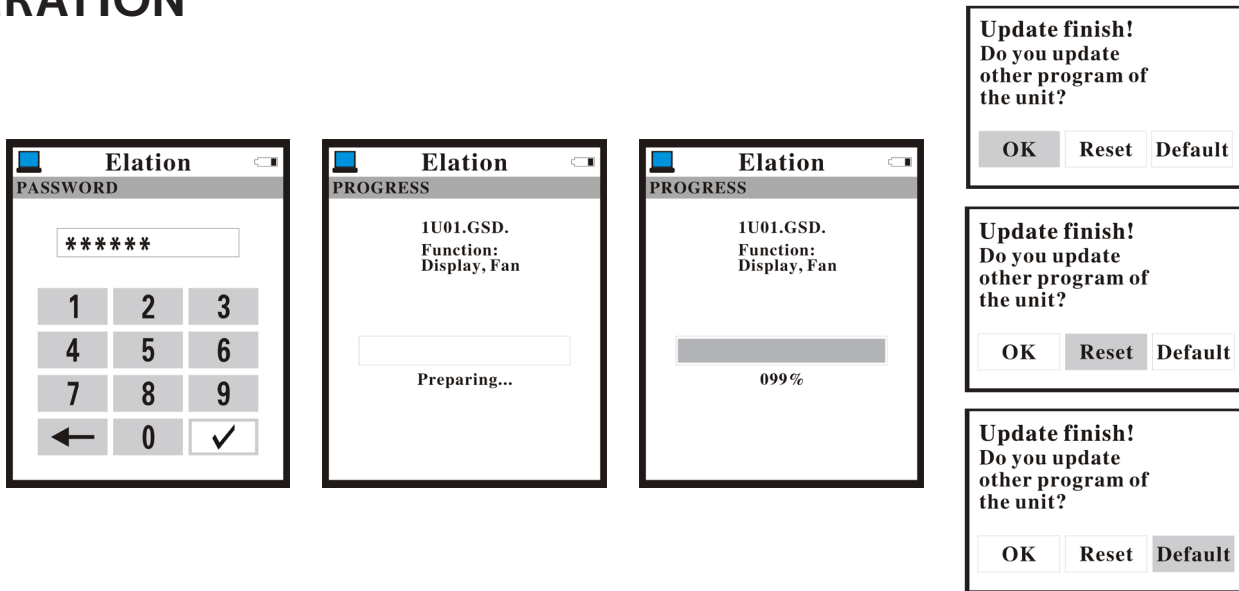

With the password entered (by default, this is 000000), select the checkmark and Press ENTER. (To delete a number that has been entered incorrectly, simply select the arrow and enter). The screen should now display a PROGRESS window, showing an empty progress bar and the message, "Preparing...". After the progress bar reaches 100%, a popup screen displays "Update finish!" and asks, "Do you update other Program of the unit?" Clicking the Confirm button allows you to upload another program, whereas the Reset button ends the uploading process.

OPTION:

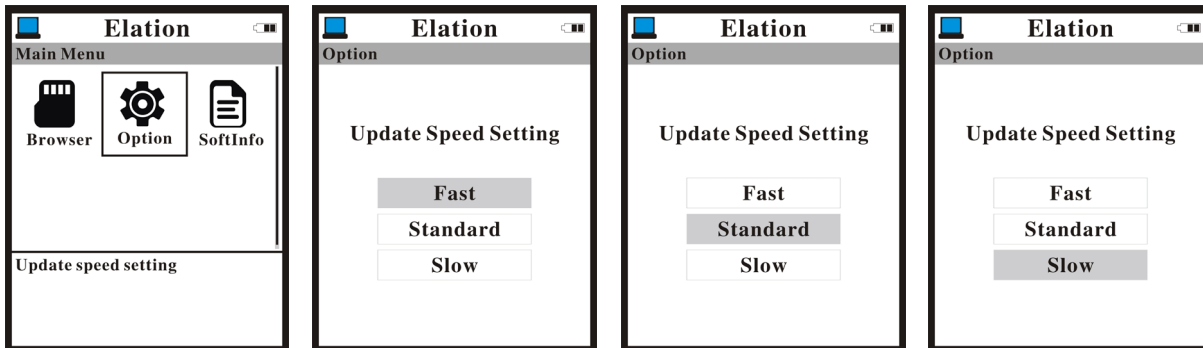

Selecting the Option button opens the Option display, which allows you to choose the Update speed Setting between Fast, Standard, and Slow.

SOFTWARE INFORMATION:

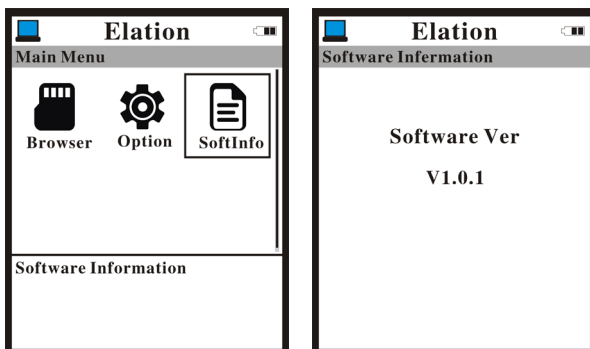

Selecting the SoftInfo button opens the Software Information display.

OPERATION

- Due to the fact that software updates often require some time to complete, it is important to make sure that the E-Loader III has sufficient power to complete the update process, in order to avoid interruption of the update process due to loss of power. It is recommended to make sure that the E-Loader III power status displays a minimum of two bars before beginning a software update.
- The maximum number of units that can be connected to the E-Loader III and updated simultaneously is **30 units**. Additionally, the length of line connecting these units should not exceed **295 feet (90 meters)**.
- The E-Loader III should be connected directly to the units that are being updated. Connections should NOT be routed through a console, a signal adapter, or any other equipment.
- Do NOT use this device to update units from manufacturers other than Elation Professional. When updating Elation-branded units, be sure to disconnect any devices made by other manufacturers from the line in order to reduce the risk of interference that can affect the update process.
- If other equipment, such as an amplifier, is connected to the unit that is being updated, switch off the power on the equipment during the update process in order to reduce the risk of interference.
- During the update process, do NOT interrupt the signal or disconnect power to either the E-Loader III or the unit that is being updated.
- When updating multiple units, in the event that some units fail to update, do NOT interrupt the update process. Instead, allow the other units to complete their update processes first, then disconnect the successfully-updated units and restart the update process for those units that have failed to update. **Note: Once an update attempt has been completed, the E-Loader III will take about 10 seconds to return to the main menu, at which point another update may be attempted.**

RECHARGING BATTERY



BATTERY

DO NOT USE DEVICE IF THE BATTERY IS DAMAGED, DEFORMED, OR HAS AN ODOR!
DO NOT DISASSEMBLE THE BATTERY!
DISPOSE OF BATTERY PROPERLY ACCORDING TO LOCAL, STATE, AND COUNTRY REGULATIONS!

DO NOT OPERATE THE DEVICE IF YOU ARE NOT QUALIFIED TO DO SO!

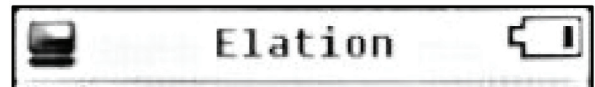

Recharge battery when indicator is low by plugging in the included power supply.



Only use the battery specified by Elation Lighting.

SPECIFICATIONS

Control / Connections:

6 Button Touch Control Panel
LCD Menu Display
3pin DMX Out
Micro SD Card Slot
Mini USB Input
With Wired Digital Communications Network

Size / Weight:

Length: 5.0" (126.7mm)
Width: 2.6" (66.9mm)
Vertical Height: 1.2" (30mm)
Weight: 0.3lbs. (0.13kg)

Electrical:

5VDC (Internal Battery)

Approvals / Ratings:

CE Certified

DIMENSIONAL DRAWING:

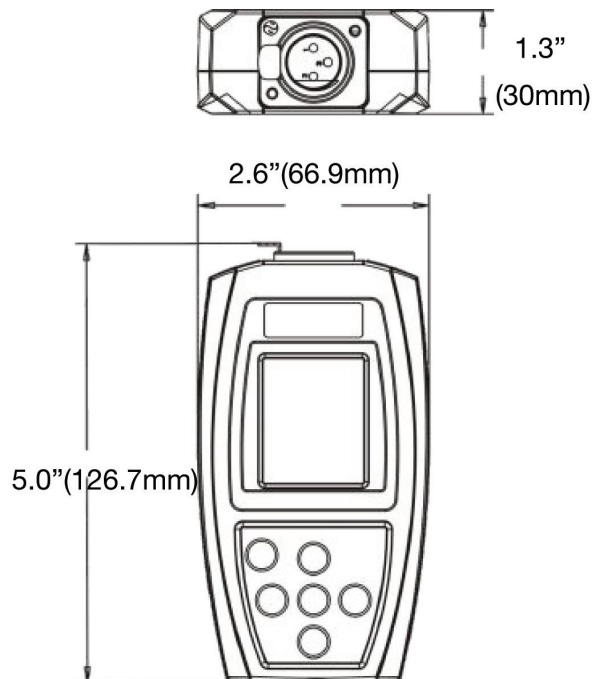

OPTIONAL COMPONENTS & ACCESSORIES

Model (SKU)	Description
AC3PM5PFM	1 ft. (0.3m) 3pin Male to 5pin Female DMX Cable
AC3PDMX5PRO	5 ft. (1.5m) 3pin PRO DMX Cable
AC5PDMX5PRO	5 ft. (1.5m) 5pin PRO DMX Cable
	Additional cable lengths available

