



DW CHORUS 48™

user manual

©2015 **ELATION PROFESSIONAL** all rights reserved. Information, specifications, diagrams, images, and instructions herein are subject to change without notice. ELATION PROFESSIONAL logo and identifying product names and numbers herein are trademarks of ELATION PROFESSIONAL. Copyright protection claimed includes all forms and matters of copyrightable materials and information now allowed by statutory or judicial law or hereinafter granted. Product names used in this document may be trademarks or registered trademarks of their respective companies and are hereby acknowledged. All non-ELATION brands and product names are trademarks or registered trademarks of their respective companies.

ELATION PROFESSIONAL and all affiliated companies hereby disclaim any and all liabilities for property, equipment, building, and electrical damages, injuries to any persons, and direct or indirect economic loss associated with the use or reliance of any information contained within this document, and/or as a result of the improper, unsafe, insufficient and negligent assembly, installation, rigging, and operation of this product.

Elation Professional USA | 6122 S. Eastern Ave. | Los Angeles, CA. 90040
323-582-3322 | 323-832-9142 fax | www.elationlighting.com | info@elationlighting.com

Elation Professional B.V. | Junostraat 2 | 6468 EW Kerkrade, The Netherlands
+31 45 546 85 66 | +31 45 546 85 96 fax | www.elationlighting.eu | info@elationlighting.eu

DOCUMENT VERSION



Please check www.elationlighting.com for the latest revision/update of this manual.

Date	Document Version	Software Version	DMX Channel Modes	Notes
11/20/15	1	≥1.02	1 / 2 / 3 / 4 / 5 / 16 / 17 / 19	Initial Release.

CONTENTS

General Information	4
Warranty	6
Safety Instructions	7
General Guidelines	8
Fixture Overview	9
Fixture Installation	10
Fixture Menu	12
DMX Channel Functions And Values	15
Cleaning and Maintenance	17
Technical Specifications	18
Optional Accessories	21

GENERAL INFORMATION

INTRODUCTION

Congratulations, you have just purchased one of the most innovative and reliable lighting fixtures on the market today! The fixture has been designed to perform reliably for years when the guidelines in this booklet are followed. Please read and understand the instructions in this manual carefully and thoroughly before attempting to operate this unit. These instructions contain important information regarding safety during use and maintenance.

UNPACKING

Every fixture has been thoroughly tested and has been shipped in perfect operating condition. Carefully check the shipping carton for damage that may have occurred during shipping. If the carton appears to be damaged, carefully inspect your unit for damage and be sure all accessories necessary to operate the unit have arrived intact. In the event damage has been found or parts are missing, please contact our customer support team for further instructions. Please do not return this unit to your dealer without first contacting customer support at the number listed below. Please do not discard the shipping carton in the trash. Please recycle whenever possible.

BOX CONTENTS

- (1) power Cable
- Manual & Warranty Card

CUSTOMER SUPPORT

Elation Professional® provides a customer support line, to provide set up help and to answer any question should you encounter problems during your set up or initial operation. You may also visit us on the web at www.elationlighting.com for any comments or suggestions. For service related issue please contact Elation Professional®.

ELATION SERVICE USA - Monday - Friday 8:00am to 5:00pm PST

Voice: 323-582-3322

Fax: 323-832-9142

E-mail: support@elationlighting.com

ELATION SERVICE EUROPE - Monday - Friday 08:30 to 17:00 CET

Voice: +31 45 546 85 30

Fax: +31 45 546 85 96

E-mail: support@elationlighting.eu

WARRANTY REGISTRATION

Please complete and mail in the enclosed warranty card or register online: <http://www.elationlighting.com/Login.aspx> to validate your purchase. All returned service items whether under warranty or not, must be freight pre-paid and accompany a return authorization (R.A.) number. The R.A. number must be clearly written on the outside of the return package. A brief description of the problem as well as the R.A. number must also be written down on a piece of paper and included in the shipping container. If the unit is under warranty, you must provide a copy of your proof of purchase invoice. Items returned without a R.A. number clearly marked on the outside of the package will be refused and returned at customer's expense. You may obtain a R.A. number by contacting customer support.



IMPORTANT NOTICE!

There are no user serviceable parts inside this unit. Do not attempt any repairs yourself; doing so will void your manufactures warranty. Damages resulting from modifications to this fixture and/or the disregard of safety and general user instructions found in this user manual void the manufactures warranty and are not subject to any warranty claims and/or repairs.

LIMITED WARRANTY

A. Elation Professional® hereby warrants, to the original purchaser, Elation Professional® products to be free of manufacturing defects in material and workmanship for a period of two years (730 days), and Elation Professional® product rechargeable batteries to be free of manufacturing defects in material and workmanship for a period of six months (180 days), from the original date of purchase. This warranty excludes discharge lamps and all product accessories. This warranty shall be valid only if the product is purchased within the United States of America, including possessions and territories. It is the owner's responsibility to establish the date and place of purchase by acceptable evidence, at the time service is sought.

B. For warranty service, send the product only to the Elation Professional® factory. All shipping charges must be pre-paid. If the requested repairs or service (including parts replacement) are within the terms of this warranty, Elation Professional® will pay return shipping charges only to a designated point within the United States. If any product is sent, it must be shipped in its original package and packaging material. No accessories should be shipped with the product. If any accessories are shipped with the product, Elation Professional® shall have no liability what so ever for loss and/or or damage to any such accessories, nor for the safe return thereof.

C. This warranty is void if the product serial number and/or labels are altered or removed; if the product is modified in any manner which Elation Professional® concludes, after inspection, affects the reliability of the product; if the product has been repaired or serviced by anyone other than the Elation Professional® factory unless prior written authorization was issued to purchaser by Elation Professional®; if the product is damaged because not properly maintained as set forth in the product instructions, guidelines and/or user manual.

D. This is not a service contract, and this warranty does not include any maintenance, cleaning or periodic check-up. During the periods as specified above, Elation Professional® will replace defective parts at its expense, and will absorb all expenses for warranty service and repair labor by reason of defects in material or workmanship. The sole responsibility of Elation Professional® under this warranty shall be limited to the repair of the product, or replacement thereof, including parts, at the sole discretion of Elation Professional®. All products covered by this warranty were manufactured after January 1, 1990, and bare identifying marks to that effect.

E. Elation Professional® reserves the right to make changes in design and/or performance improvements upon its products without any obligation to include these changes in any products theretofore manufactured.

F. No warranty, whether expressed or implied, is given or made with respect to any accessory supplied with the products described above. Except to the extent prohibited by applicable law, all implied warranties made by Elation Professional® in connection with this product, including warranties of merchantability or fitness, are limited in duration to the warranty periods set forth above. And no warranties, whether expressed or implied, including warranties of merchantability or fitness, shall apply to this product after said periods have expired. The consumer's and/or dealer's sole remedy shall be such repair or replacement as is expressly provided above; and under no circumstances shall Elation Professional® be liable for any loss and/or damage, direct and/or consequential, arising out of the use of, and/or the inability to use, this product.

G. This warranty is the only written warranty applicable to Elation Professional® products and supersedes all prior warranties and written descriptions of warranty terms and conditions heretofore published.

SAFETY INSTRUCTIONS



This fixture is an extremely sophisticated piece of electronic equipment. To guarantee a smooth operation, it is important to follow the guidelines in this manual. The manufacturer of this device will not accept responsibility for damages resulting from the misuse of this fixture due to the disregard of the information printed in this manual.



This device falls under **PROTECTION CLASS 1**. It's essential this device be grounded properly. Only qualified personnel should perform all electrical connections.



I N D O O R S U S E O N L Y !
DO NOT EXPOSE FIXTURE RAIN AND MOISTURE!



UNPLUG POWER BEFORE SERVICING FIXTURE!
DO NOT PLUG FIXTURE INTO A DIMMER PACK!
NEVER TOUCH FIXTURE DURING OPERATION, AS IT MAY BE HOT!



NEVER LOOK DIRECTLY INTO THE LIGHT SOURCE!
SENSITIVE PERSONS MAY SUFFER AN EPILEPTIC SHOCK!

- For proper operation, follow the **Installation** guidelines described in this manual. Only qualified and certified personnel should perform installation of this fixture and only the original rigging parts (brackets) included with this fixture should be used for installation. Any modifications will void the original manufacturer's warranty and increase the risk of damage and/or personal injury.
- Never look directly into the light source of this fixture to prevent risk of injury to your retina, which may induce blindness. Those suffering from **EPILEPSY** should avoid looking directly into the light source of this unit at all times.
- The fan and air inlets must remain clean and never blocked. Allow approx. 6" (15cm) between this fixture and other devices or a wall for proper cooling.
- Always disconnect from main power source before performing any type of service and/or cleaning procedure. Only handle the power cord by the plug end, never pull out the plug by tugging the wire portion of the cord.
- Do not operate this fixture if the power cord has become frayed, crimped and/or damaged. If the power cord is damaged, replace it immediately with a new one of similar power rating.

GENERAL GUIDELINES

- **NEVER OPEN THIS FIXTURE WHILE IN USE!**
- During the initial operation of this fixture, a light smoke or smell may emit from the interior of the fixture. This is a normal process and is caused by excess paint in the interior of the casing burning off from the heat associated with the lamp and will decrease gradually over time.
- This fixture is a professional lighting effect designed for **INDOOR / DRY LOCATIONS ONLY** on stage, in nightclubs, theatres, etc.
- Please make sure there are **NO FLAMMABLE MATERIALS** close to the fixture while operating, to prevent any fire hazard.
- The fixture must be installed in a location with adequate ventilation, at least 1.5 feet (.5m) from adjacent surfaces. Be sure no air ventilation slots are blocked.
- **DO NOT** attempt installation and/or operation without knowledge how to do so.
- **DO NOT** permit operation by persons who are not qualified to operate this type of fixture. Most damages are the result of operations by nonprofessionals.
- Consistent operational breaks may ensure the fixture will function properly for many years to come.
- **DO NOT** shake fixture, avoid brute force when installing and/or operating fixture.
- Always install the fixture with an appropriate safety cable. When installing the fixture in a suspended environment, always use mounting hardware that is no less than M10 x 25 mm, also be sure the hardware is insert in the pre-arranged screw holes in the bracket of the fixture.
- Use the original packaging and materials to transport the fixture in for service.
- **DO NOT TOUCH** the housing bare-hand during its operation. Turn OFF the power and allow approximately 15 minutes for the fixture to cool down before replacing or serving.

FIXTURE OVERVIEW

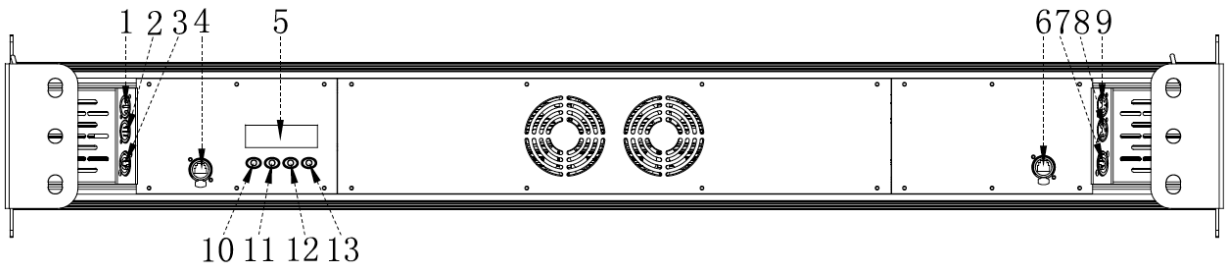

- . + **3pin DMX IN**
- / + **5pin DMX IN**
- 0+ **power IN**
- 1+ **RJ45 NET IN**
- 2+ **LCD Menu Control Display**
- 3+ **RJ45 NET OUT**
- 4+ **power OUT**
- 5+ **3pin DMX OUT**
- 6+ **5pin DMX OUT**
- . - + **MODE Button**
- . . + **UP Button**
- . / + **DOWN Button**
- . 0+ **ENTER Button**

FIXTURE INSTALLATION



FLAMMABLE MATERIAL WARNING

Keep fixture at least 5.0 ft. (1.5m) away from any flammable materials, decorations, pyrotechnics, etc.



ELECTRICAL CONNECTIONS

A qualified electrician should be used for all electrical connections and/or installations.

CAUTIONS

- For added protection, mount the fixture in areas outside walking paths, seating areas, or in areas where unauthorized personnel might reach the fixture.
- Ambient operating temperature range for this fixture is **5°F to 113°F (-15°C to 45°C)**. Do not use the fixture under or above this temperature.
- Before mounting the fixture to any surface, make sure the installation area can hold a minimum point load of 10 times the weight of the fixture.
- Fixture installation must always be secured with a secondary safety attachment, such as an appropriate safety cable.
- Never stand directly below the device when mounting, removing or servicing.

POWER LINKING

Max number of units that can be power linked is **4 units @110V** and **6 units @240V**.

CLAMP MOUNTING

The fixture provides integrated and adjustable rigging brackets. When mounting this fixture to truss make sure to secure appropriately rated clamps to the rigging brackets using a M10 screw fitted through the center hole.

MOUNTING POINTS

- Overhead mounting requires extensive experience, including amongst others calculating working load limits, installation material being used, and periodic safety inspection of all installation material and the device. If you lack these qualifications, do not attempt the installation yourself. Improper installation can result in bodily injury.
- Fixture is fully operational in the specific mounting positions as illustrated below.

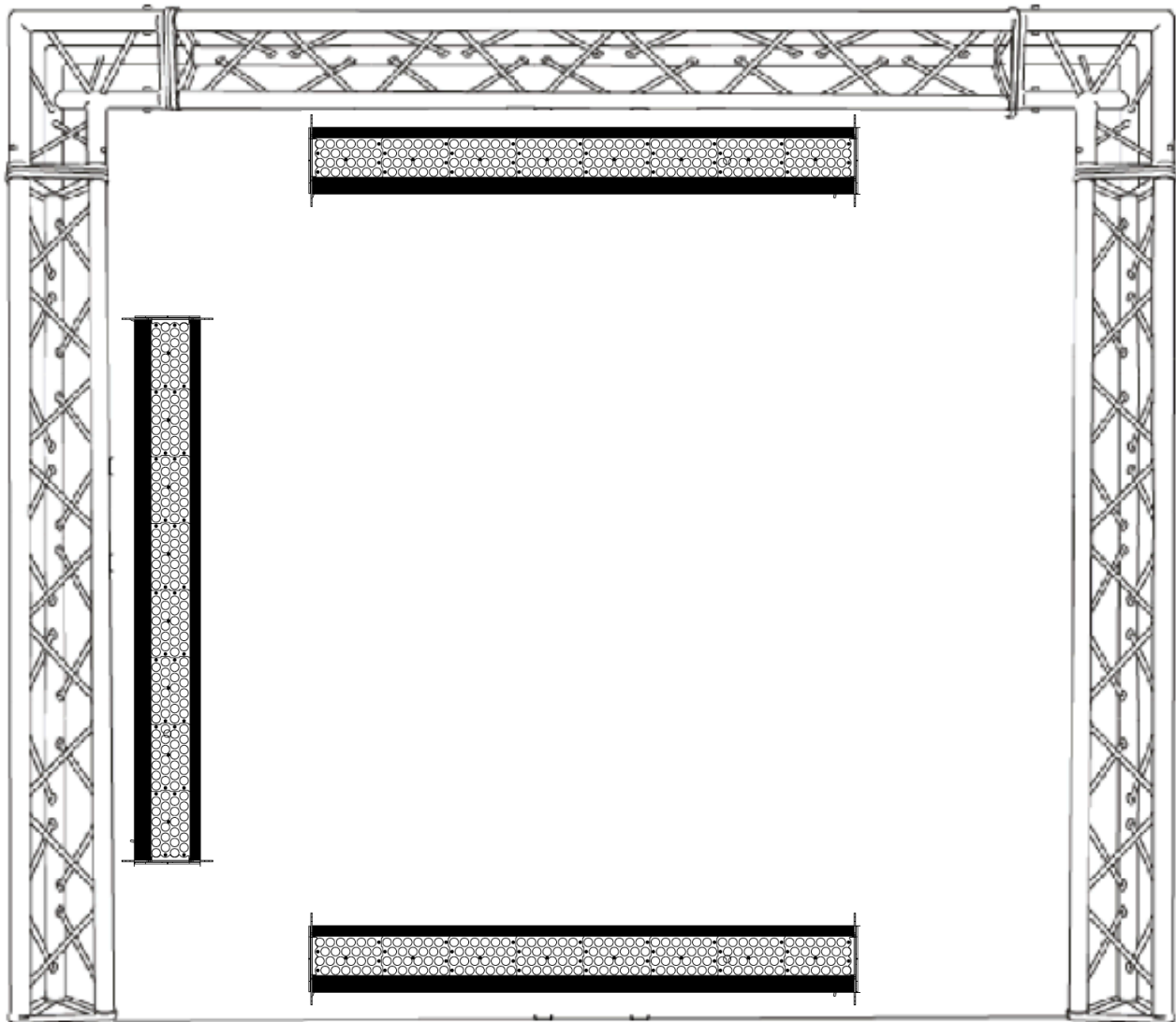

SAFETY CABLE

ALWAYS USE A SAFETY CABLE WHENEVER INSTALLING THIS FIXTURE IN A SUSPENDED ENVIRONMENT TO ENSURE THE FIXTURE WILL NOT DROP IF THE CLAMP FAILS.

FIXTURE MENU

ON-BOARD SYSTEM MENU

The fixture comes with an easy to navigate system menu. The next section will detail the functions of each command in the system menu.

LCD MENU CONTROL PANEL

The control panel (see image below) located on the back of the fixture allows you to access the main menu and make all necessary adjustments to the fixture. During normal operation, pressing **MODE** button once will access the fixture's main menu. Once in the main menu you can navigate through the different functions and access the sub-menus with the **UP**, and **DOWN** buttons. Once you reach a field that requires adjusting, press the **ENTER** button to activate that field and use the **UP** and **DOWN** buttons to adjust the field. Pressing the **ENTER** button once more will confirm your setting. You may exit the main menu at any time without making any adjustments by pressing the **MODE** button.

 **NOTE:** When **LCD. Set Key Lock** is set to **ON**, the LCD Menu Control Display will shut OFF and lockout after 30 seconds of no use. Press and hold the **MODE** button for 10 seconds to unlock the LCD display.

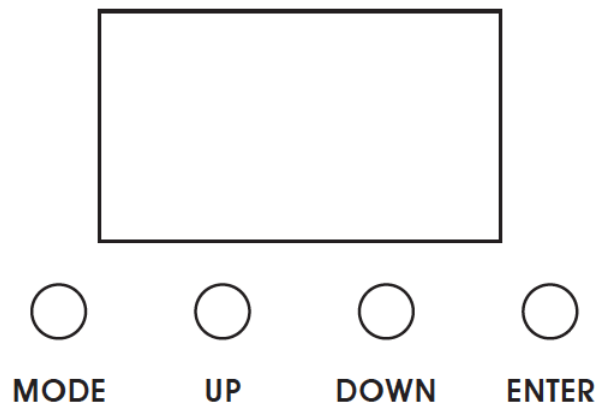

INFORMATION DISPLAYED DURING INITIAL POWER ON

When the fixture is initially powered ON, the display shows the following information:



**ELATION® COLOUR CHORUS 48™
SYSTEM MENU**

Specifications are subject to change without any prior written notice.
Default Settings in **BOLD**.

MENU	OPTIONS / VALUES		DESCRIPTION
Set Address	ADDR:001 - XXX		Set DMX Address.
User Mode	1 Channel, 2 Channel, 3 Channel, 4 Channel, 5 Channel, 16 Channel, 17 Channel, 19 Channel		Set DMX Mode.
Effect	Manual C Manual W Manual S Manual D	0-255 0-255 0-255 0-255	Set Cool White DMX Value Set Warm White DMX Value Set Strobe DMX Value Set Dimmer DMX Value
Function	Status	Remote DMX Adrs: ON / OFF No DMX Mode: Black Out / Hold	
	Fixture ID	Service PIN Device IP Addr Universe	Password = 050 XXX.XXX.XXX.XXX XXX NOTE: Service Passcode must be entered to access these menus.
	Protocol Set	ArtNet , Kling-Net	
	Net Switch	ON / OFF	
	Fan. Set	LED Fan	Auto High Low
	LCD. Set	Display Key Lock Disp Flash	ON / OFF ON / OFF ON / OFF
	Temp. C/F	Celsius Fahrenheit	
	Dim. Curve	Standard , Stage, TV, Architectural, Theatre	
	Pixel Flip	Standard / Flip	
	Reset to Default	OFF / ON	
Information	Time. Info	Current	XXX
		Total	XXX
		Last	XXX
		Timer PIN	Passcode = 050
		Clear Last	OFF / ON
	Temp. Info	LED Temp	XXX C
	Model. Info	DWC 24	
Software.V	≥1.02		

DIMMING CURVES

The **DimCurve** menu allows you to select one of the following preset dimming curves: **Standard, Stage, TV, Architec, Theatre, or Default.**

(See diagram below for more details)

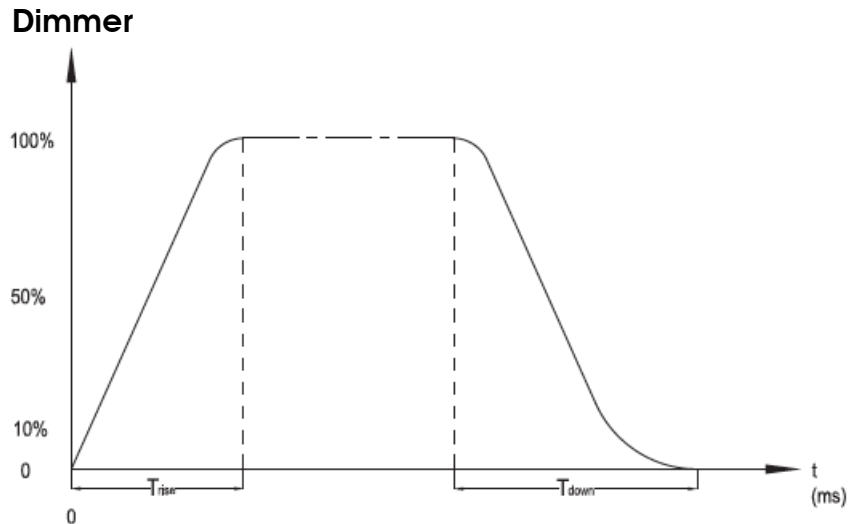

Ramp Effect	0 255 OS (Fade Time)		0 255 1S (Fade Time)	
	T _{rise} (ms)	T _{down} (ms)	T _{rise} (ms)	T _{down} (ms)
Standard	0	0	0	0
Stage	780	1100	1540	1660
TV	1180	1520	1860	1940
Architectural	1380	1730	2040	2120
Theatre	1580	1940	2230	2280

PIXEL FLIP

Select the desired starting LED Group direction from one of the following modes below via **UP/DOWN** buttons and then press **ENTER** to confirm.

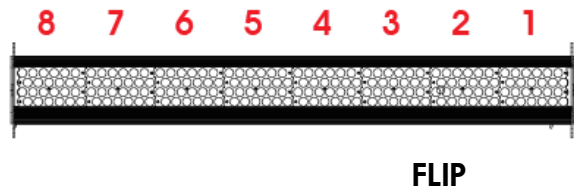
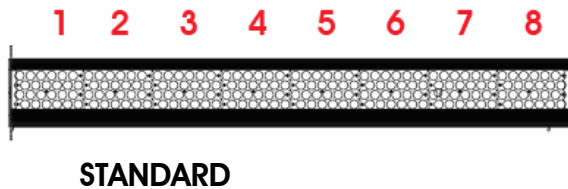

DMX CHANNEL FUNCTIONS AND VALUES

ELATION© DW CHORUS 48™

DMX Channel Values / Functions Version 1 (19 DMX Channels)

Specifications are subject to change without any prior written notice.

*Control of LED Modules depends on the Pixel Flip setting.

MODE / CHANNEL								VALUE	FUNCTION
1 CH	2 CH	3 CH	4 CH	5 CH	16 CH	17 CH	19 CH		
1									ALL LEDs
								0-255	VARIABLE COLOR TEMP 2,700-6,700K
	1	1	1	1					COOL WHITE - LED GROUP 1 - 8
								0-255	0 to 100%
	2	2	2	2					WARM WHITE - LED GROUP 1 - 8
								0-255	0 to 100%
					1	1	1		COOL WHITE - LED GROUP 1
								0-255	0 to 100%
					2	2	2		WARM WHITE - LED GROUP 1
								0-255	0 to 100%
					3	3	3		COOL WHITE - LED GROUP 2
								0-255	0 to 100%
					4	4	4		WARM WHITE - LED GROUP 2
								0-255	0 to 100%
					5	5	5		COOL WHITE - LED GROUP 3
								0-255	0 to 100%
					6	6	6		WARM WHITE - LED GROUP 3
								0-255	0 to 100%
					7	7	7		COOL WHITE - LED GROUP 4
								0-255	0 to 100%
					8	8	8		WARM WHITE - LED GROUP 4
								0-255	0 to 100%
					9	9	9		COOL WHITE - LED GROUP 5
								0-255	0 to 100%
					10	10	10		WARM WHITE - LED GROUP 5
								0-255	0 to 100%
					11	11	11		COOL WHITE - LED GROUP 6
								0-255	0 to 100%
					12	12	12		WARM WHITE - LED GROUP 6
								0-255	0 to 100%
					13	13	13		COOL WHITE - LED GROUP 7
								0-255	0 to 100%
					14	14	14		WARM WHITE - LED GROUP 7
								0-255	0 to 100%
					15	15	15		COOL WHITE - LED GROUP 8
								0-255	0 to 100%
					16	16	16		WARM WHITE - LED GROUP 8
								0-255	0 to 100%

ELATION® DW CHORUS 48™									
DMX Channel Values / Functions Version 1 (19 DMX Channels)									
Specifications are subject to change without any prior written notice.									
*Control of LED Modules depends on the Pixel Flip setting.									
MODE / CHANNEL								VALUE	FUNCTION
1 CH	2 CH	3 CH	4 CH	5 CH	16 CH	17 CH	19 CH		
			3	3			17		STROBE
								0-31	NO Function
								32-95	Variable Strobe Effect SLOW to FAST
								96-127	LEDs ON
								128-159	Pulse Effect In Sequence SLOW to FAST
								160-191	LEDs ON
								192-223	Random Strobe Effect SLOW to FAST
								224-255	LEDs ON
		3	4	4		17	18		MASTER DIMMER
								0-255	Intensity 0 to 100%
				5			19		DIMMING CURVE MODES
								0-20	STANDARD
								21-40	STAGE
								41-60	TV
								61-80	ARCHITECTURAL
								81-100	THEATRE
								101-255	Default to Unit Setting

CLEANING AND MAINTENANCE



C A U T I O N

Disconnect power before cleaning or maintenance.

CLEANING

Frequent cleaning is recommended to insure proper function, optimized light output, and an extended life. The frequency of cleaning depends on the environment in which the fixture operates: damp, smoky or particularly dirty environments can cause greater accumulation of dirt on the fixture's optics.

- Clean the external lens surface at least every 20 days with a soft cloth to avoid dirt/debris accumulation.
- Never use alcohol, solvents, or ammonia based cleaners.

MAINTENANCE

Regular inspections are recommended to insure proper function and extended life. There are no user serviceable parts inside this fixture, please refer all other service issues to an authorized Elation service technician. Should you need any spare parts, please order genuine parts from your local Elation dealer.

Please refer to the following points during routine inspections:

- A detailed electric check by an approved electrical engineer every three months, to make sure the circuit contacts are in good condition and prevent overheating.
- Be sure all screws and fasteners are securely tightened at all times. Loose screws may fall out during normal operation resulting in damage or injury as larger parts could fall.
- Check for any deformations on the housing, color lenses, rigging hardware and rigging points (ceiling, suspension, trussing). Deformations in the housing could allow for dust to enter into the fixture. Damaged rigging points or unsecured rigging could cause the fixture to fall and seriously injure a person(s).
- Electric power supply cables must not show any damage, material fatigue or sediments. Never remove the ground prong from the power cable.

TECHNICAL SPECIFICATIONS

SOURCE

(96) CW + (96) WW 3W Lumi™ LEDs
100,000 Hour Average LED Life*

*LED Life may vary depending on several factors including but not limited to: Environmental Conditions, Power/Voltage, Usage Patterns (On-Off Cycling), Control, and Dimming.

EFFECTS

Strobe and Chase Effects / Variable Dimming Curves

CONTROL / CONNECTIONS

(8) DMX Channel Modes
4 Button Control Panel and LCD Menu Display
ArtNet™ / KlingNET™ / RDM Protocol Support
(2) RJ45 Ports, 3pin and 5pin DMX In/Out
Power In/Out
Power Link Up To (4) Units at 120V (6) Units at 230V

SIZE / WEIGHT

Length: 46.5" (1182mm)
Width: 7.5" (194.1mm)
Vertical Height: 7.6" (192.5mm)
Weight: 37.0 lbs. (16.8kg)

ELECTRICAL / THERMAL

AC 110-250V - 50/60Hz
347W Max Power Consumption
5°F to 113°F (-15°C to 45°C)

APPROVALS / RATINGS

CE | cETLus | IP30



Please Note: Specifications and improvements in the design of this unit and this manual are subject to change without any prior written notice.

PHOTOMETRIC DATA

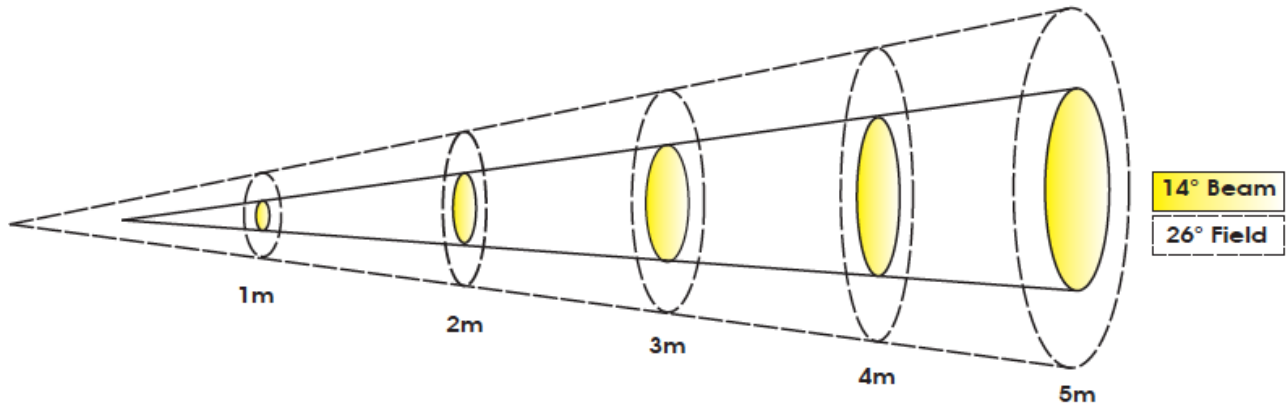

Distance	1m	3.3 ft	2m	6.6 ft	3m	9.8 ft	4m	13.1 ft	5m	16.4 ft
14° Beam Diameter	0.3	1.0	0.6	2.0	0.98	3.2	1.28	4.2	1.58	5.2
26° Field Diameter	0.47	1.5	0.9	3.0	1.35	4.4	1.79	5.9	2.23	7.3
Photometrics	lux	fc	lux	fc	lux	fc	lux	fc	lux	fc
COOL WHITE	24,475	2,274	13,108	1,218	7,283	677	4,598	427	3,072	285
WARM WHITE	15,672	1,456	9,194	854	5,108	475	3,084	287	2,021	188
FULL ON	32,644	3,033	16,842	1,565	9,514	884	5,942	552	3,998	371

Please Note: Specifications and improvements in the design of this unit and this manual are subject to change without any prior written notice.

DIMENSIONAL DRAWINGS

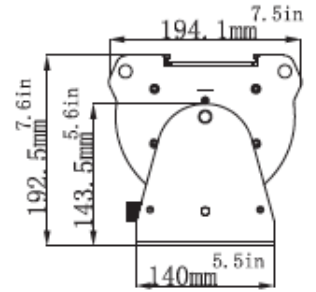
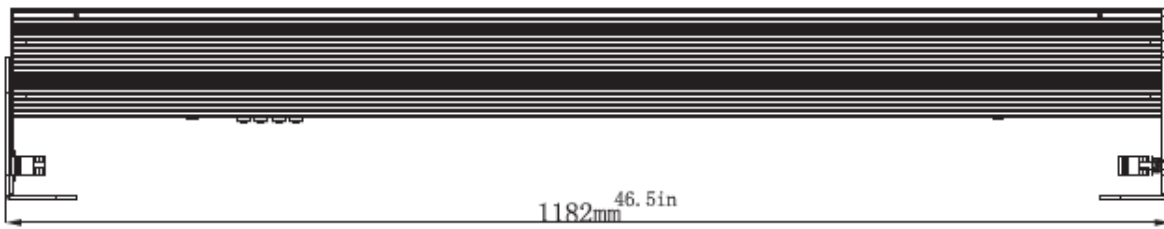
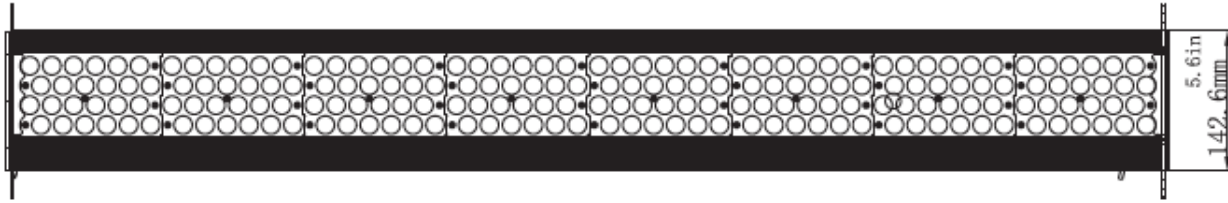

OPTIONAL ACCESSORIES

ORDER CODE	ITEM
TRIGGER CLAMP	Heavy Duty Wrap Around Hook Style Clamp
LSF601	60 x 1° 72" (1829mm) x 3.5" (89mm) Light Shaping Filter
EWDMXSYSTEM	Wireless DMX System (1 Transmitter, 1 Receiver)
EWDMXT	Wireless DMX Transmitter
EWDMXR	Wireless DMX Receiver
PLC3	3' (1m) powerCON PRO Link Cable
AC3PDMX5PRO	5 ft. (1.5m) 3pin PRO DMX Cable
AC5PDMX5PRO	5 ft. (1.5m) 5pin PRO DMX Cable
CAT005	5' (1.5m) CAT6 EtherCON Cable
	Additional Cable Lengths Available

