



## KL Fresnel 8 CW

### Photometric Test Report

©2020 ELATION PROFESSIONAL all rights reserved. Information, specifications, diagrams, images, and instructions herein are subject to change without notice. ELATION PROFESSIONAL logo and identifying product names and numbers herein are trademarks of ELATION PROFESSIONAL. Copyright protection claimed includes all forms and matters of copyrightable materials and information now allowed by statutory or judicial law or hereinafter granted. Product names used in this document may be trademarks or registered trademarks of their respective companies and are hereby acknowledged. All non-ELATION brands and product names are trademarks or registered trademarks of their respective companies.

**Elation Professional USA** | 6122 S. Eastern Ave. | Los Angeles, CA. 90040

323-582-3322 | 323-832-9142 fax | [www.elationlighting.com](http://www.elationlighting.com) | [info@elationlighting.com](mailto:info@elationlighting.com)

**Elation Professional B.V.** | Junostraat 2 | 6468 EW Kerkrade, The Netherlands

+31 45 546 85 66 | +31 45 546 85 96 fax | [www.elationlighting.eu](http://www.elationlighting.eu) | [info@elationlighting.eu](mailto:info@elationlighting.eu)

**Elation Professional Mexico** | AV Santa Ana 30 | Parque Industrial Lerma, Lerma, Mexico 52000

+52 (728) 282-7070

# CONTENTS

Testing Process	4
Zoom In	5
Zoom Out	8

# Testing Process

## Total Lumen Measurements

Lumens are measured using a Viso Systems Lab Spion. As a goniophotometer, the Viso calculates the field lumens of the fixture by taking multiple measurements across the light beam.

Many lumens figures provided for entertainment lighting fixtures are only  $2\pi$  sphere values, some even emphasize the LED engine lumens. All Elation product photometric data is the actual light output from the fixture lens, never a theoretical value based on calculation or using the source lumens as the fixtures output. We advise to always compare total fixture lumens acquired with identical measurement systems when comparing lighting fixtures.

## Test Lab Equipment and Process

Elation operates an optical testing laboratory at its Los Angeles, CA headquarters to provide accurate photometric data for its lighting products. The testing lab is both light and climate-controlled and contains a variety of precise lighting measurement systems. Fixtures are analyzed with the sophisticated [Viso Systems Lab Spion](#) equipment, which measures all light and color parameters by panning the light beam at a precise speed and from different angles through a calibrated, laser aligned light and color sensor. Test data is collected and summarized by the Viso Light Inspector software. This type of measurement system is referred to as a Goniophotometer.

The Viso software calculates all relevant types of measurements, from beam angles, candela to center light intensity at a variety of distances to the latest color quality measurements like TM30 or CQS as well as accurate color temperature. This wealth of data is then processed by an Elation specific template which is included in the photometric test report for various fixture conditions such as zoom angles and color correction filters.

The Viso software also creates IES (Illuminating Engineering Society) files for each test report. IES is an industry standard file format created for the easy electronic transfer of photometric test data, which is widely used by lighting manufacturers for photometric data distribution.

Additionally, fixtures are periodically rechecked for accuracy using various hand-held light meters including one or more of the devices listed below. This is done to ensure the test data contained in this report is as accurate as possible.

[Asenstek Lighting Passport](#) | [Konica Minolta T-10](#) | [Sekonic C700T](#)

**Total Lumen Output: 5982 lm**

**Color Temperature: 5839 K**

**CRI: 96.6**

**TLCI: 97**

**TM30: 92.1**

**CQS: 93.3**

**Measurement Date: 6/12/2018**

**Voltage: 112 V, Current: 2.63 A**

**Power: 295 W**

**Efficacy: 20 Lumen/Watt**

**Spectral distribution**  
Dominant Wavelength 595

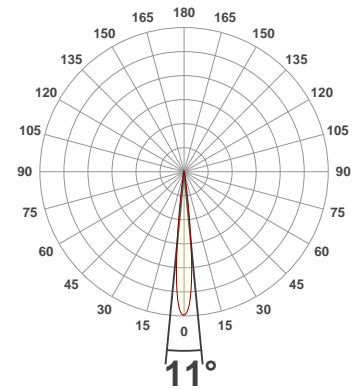
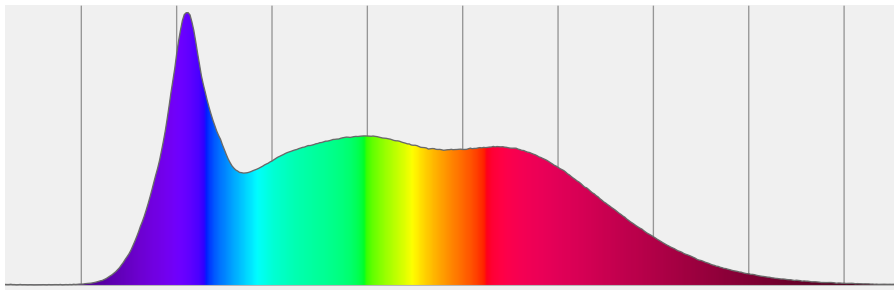

**Beam details**

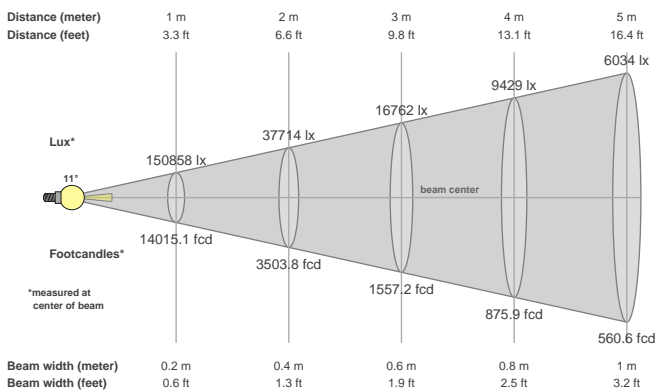

**Beam angles**

Beam angle 50%	Field angle 10%	Cutoff angle 2,5%
11°	17.9°	24.7°

**Beam intensities**

Peak intensity	Int. ratio in 120° cone	Int. ratio in 90° cone
151016 cd	100.0%	100.0%

**Beam Intensities from 1-20m**

M	1	2	3	4	5	6	7	8	9	10	11	12	13	14	15	16	17	18	19	20
FT	3.3	6.6	9.8	13.1	16.4	19.7	23	26.2	29.5	32.8	36.1	39.4	42.7	45.9	49.2	52.5	55.8	59.1	62.3	65.6
LX	150858	37714	16762	9429	6034	4190	3079	2357	1862	1509	1247	1048	893	770	670	589	522	466	418	377
FC	14015.1	3503.8	1557.2	875.9	560.6	389.3	286	219	173	140.2	115.8	97.3	82.9	71.5	62.3	54.7	48.5	43.3	38.8	35

### Color Details

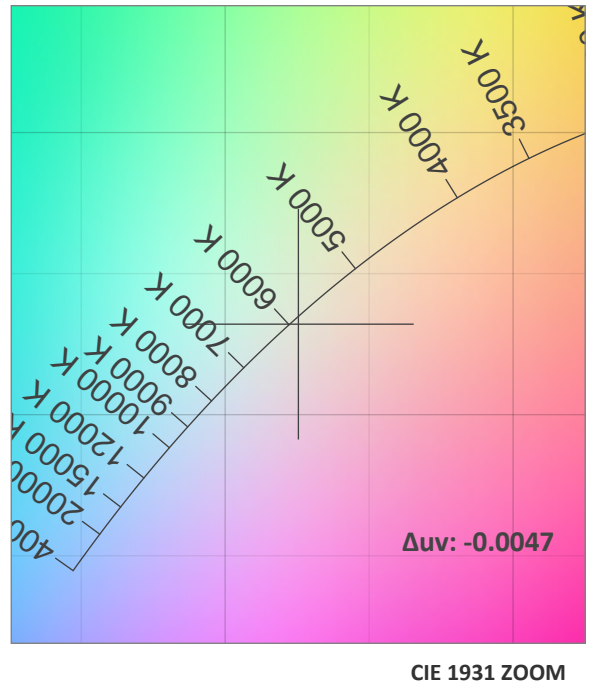
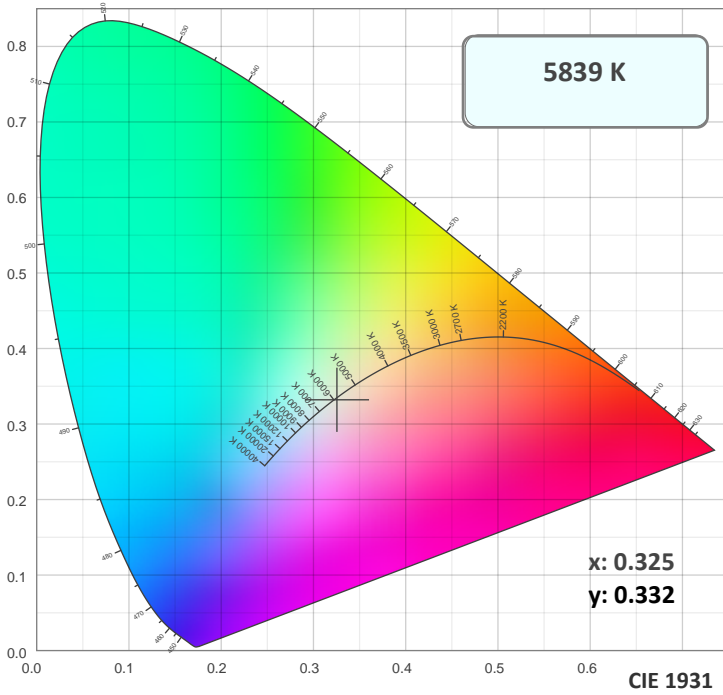

#### TM30: 92.1

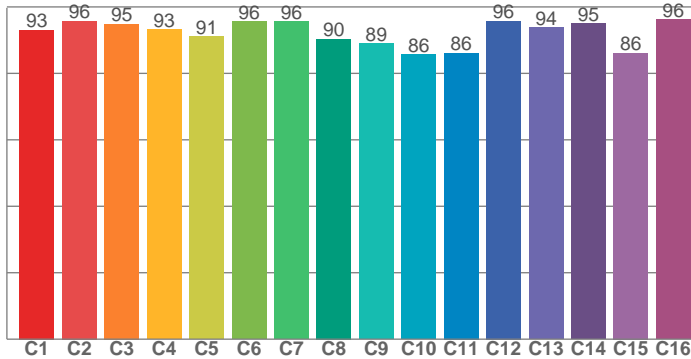

#### CRI: 96.6 (R1-R8)

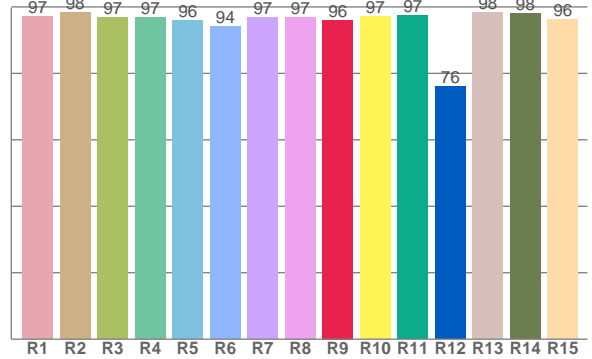

#### CRI R values, only R1-R8 are used to calculate final CRI value

R1	R2	R3	R4	R5	R6	R7	R8	R9	R10	R11	R12	R13	R14	R15
97.2	98.4	96.8	96.8	95.8	94.1	96.9	97.0	96.1	97.0	97.4	76.0	98.4	98.0	96.2

#### TM30 C Values, 16 binned values out of total of 99 C values

C1	C2	C3	C4	C5	C6	C7	C8	C9	C10	C11	C12	C13	C14	C15	C16
93.0	95.8	94.9	93.2	91.2	95.6	95.6	90.4	89.0	85.6	86.1	95.8	93.9	95.1	86.1	96.2

#### CQS Q Values

Q1	Q2	Q3	Q4	Q5	Q6	Q7	Q8	Q9	Q10	Q11	Q12	Q13	Q14	Q15
94.4	99.4	88.2	85.3	89.8	93.3	97.4	98.0	97.2	95.8	94.1	94.6	95.5	96.9	96.3

#### CQS: 93.3

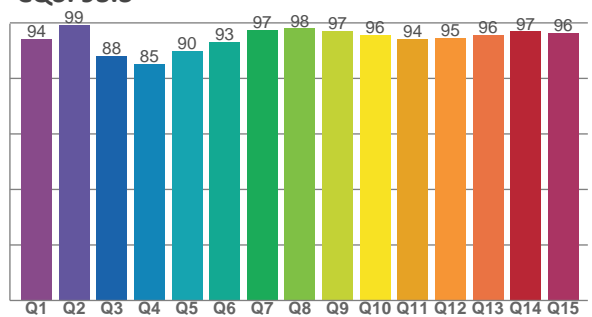

### Color Parameters

Color Temperature	Color Rendering Index	Red Component	Color Fidelity	Color Gamut	Color Quality Scale	Color Coordinate CIE 1931	Color Coordinate CIE 1931	Color Coordinate	Color Coordinate	Color Diviation from Black
CCT	CRI	CRI R9	TM30 Rf	TM30 Rg	CQS	x	y	u	v	$\Delta uv$
5839 K	96.6	96.1	92.1	99.5	93.3	0.325	0.332	0.206	0.315	-0.0047

TM30 Details

**Rf 92.1**  
Fidelity Index Rf

**Rg 99.5**  
Gamut Index Rg

Hue Bin	R <sub>f</sub>	Graphic shifts (%)	
		Chroma	Hue
1	93	-2%	1%
2	96	0%	2%
3	95	0%	1%
4	93	-2%	0%
5	91	-4%	0%
6	96	-3%	0%
7	96	-3%	1%
8	90	-3%	5%
9	89	-2%	10%
10	86	0%	9%
11	86	4%	8%
12	96	3%	1%
13	94	4%	-1%
14	95	1%	-2%
15	86	8%	-8%
16	96	-1%	0%

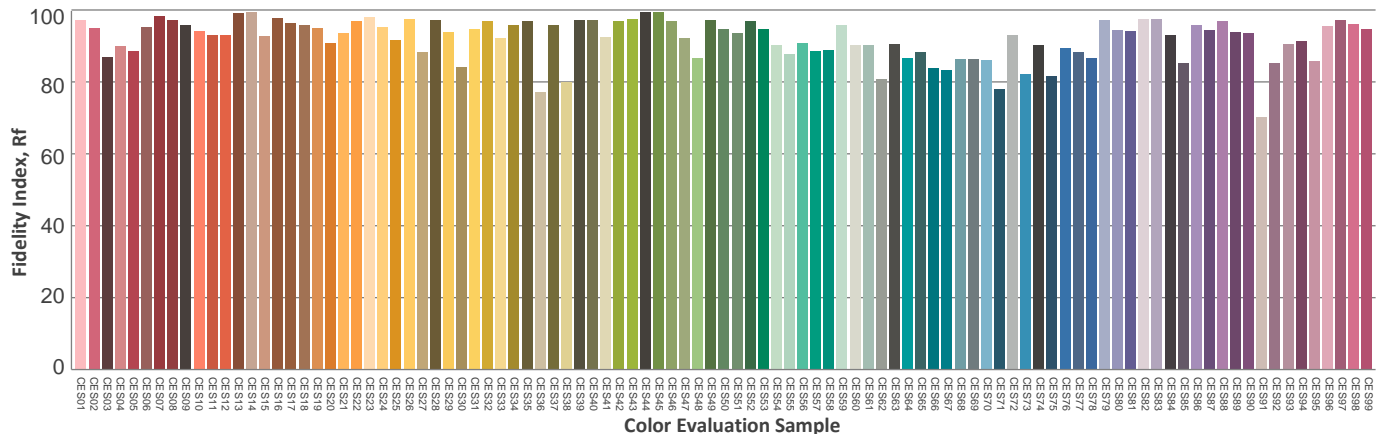
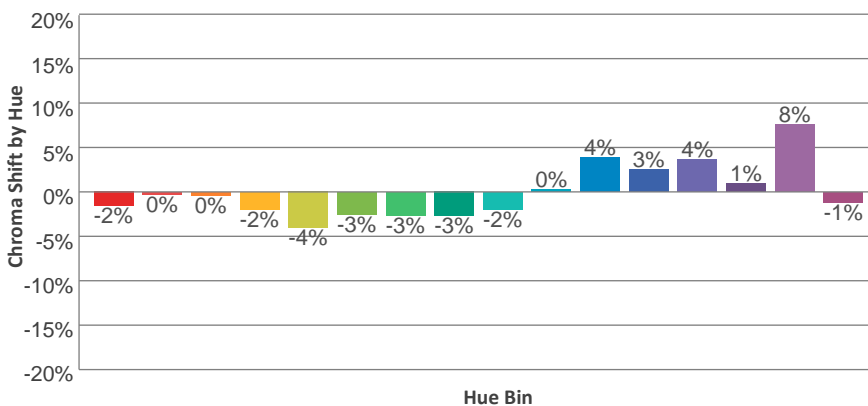
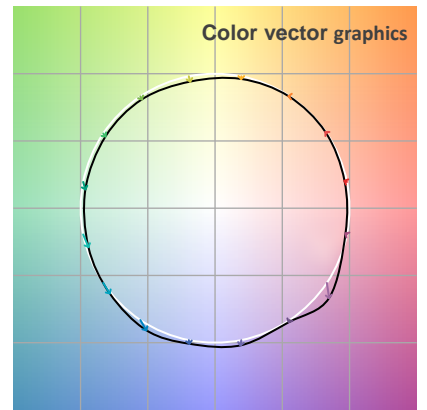
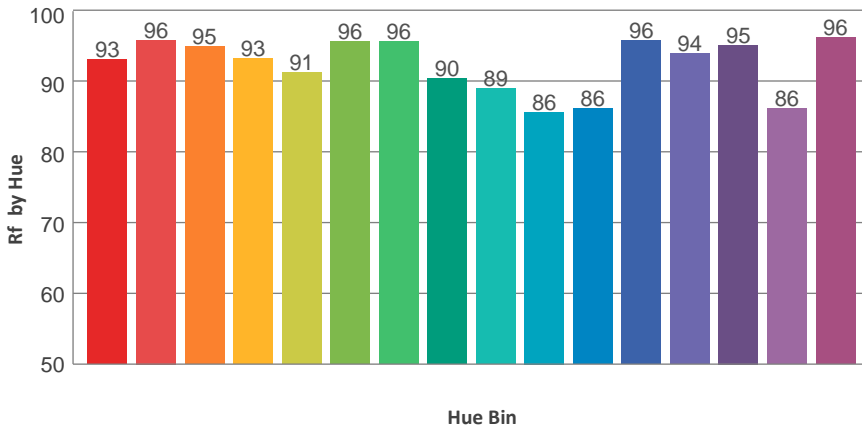
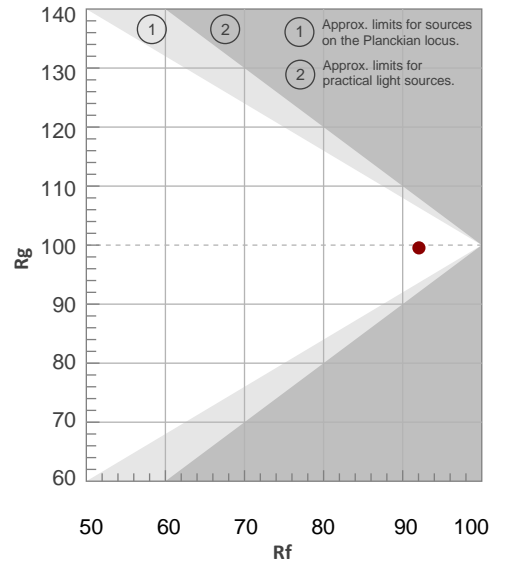

**Total Lumen Output: 10792 lm**

**Color Temperature: 5702 K**

**CRI: 96.7**

**TLCI: 97**

**TM30: 92.2**

**CQS: 93.2**

**Measurement Date: 6/12/2018**

**Voltage: 113 V, Current: 2.62 A**

**Power: 295 W**

**Efficacy: 37 Lumen/Watt**

**Spectral distribution**  
Dominant Wavelength 592

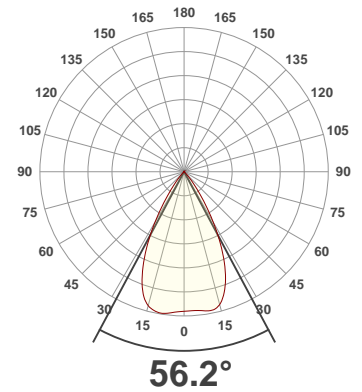
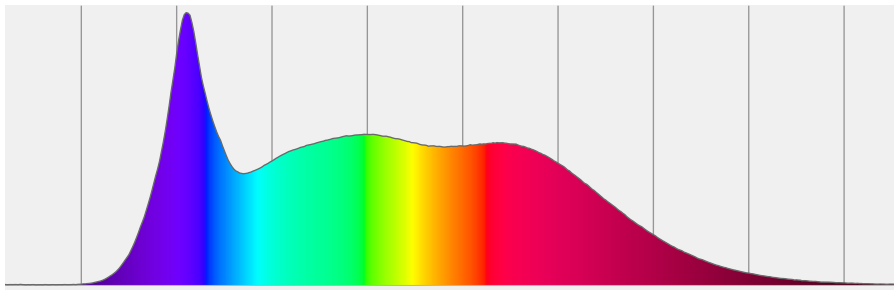

**Beam details**

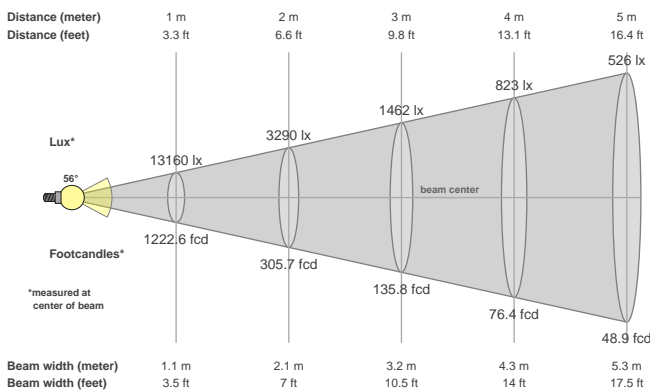

**Beam angles**

Beam angle 50%	Field angle 10%	Cutoff angle 2,5%
<b>56.2°</b>	<b>77°</b>	<b>87.6°</b>

**Beam intensities**

Peak intensity	Int. ratio in 120° cone	Int. ratio in 90° cone
<b>13507 cd</b>	<b>99.3%</b>	<b>99.1%</b>

**Beam Intensities from 1-20m**

M	1	2	3	4	5	6	7	8	9	10	11	12	13	14	15	16	17	18	19	20
<b>FT</b>	3.3	6.6	9.8	13.1	16.4	19.7	23	26.2	29.5	32.8	36.1	39.4	42.7	45.9	49.2	52.5	55.8	59.1	62.3	65.6
<b>LX</b>	13160	3290	1462	823	526	366	269	206	162	132	109	91	78	67	58	51	46	41	36	33
<b>FC</b>	1222.6	305.7	135.8	76.4	48.9	34	25	19.1	15.1	12.2	10.1	8.5	7.2	6.2	5.4	4.8	4.2	3.8	3.4	3.1



### Color Details

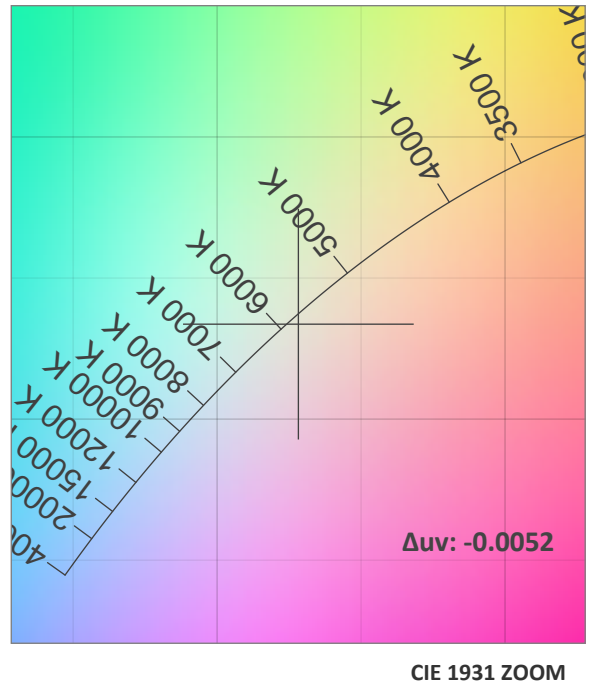
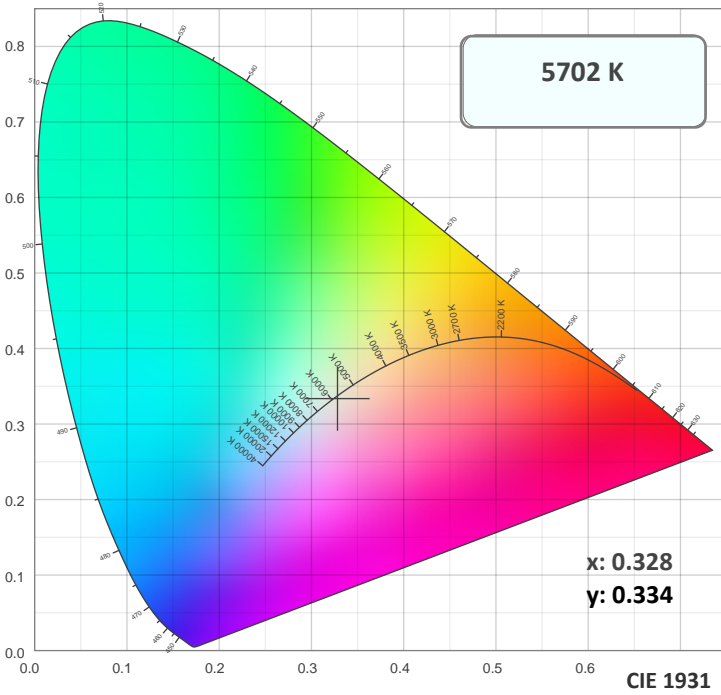

#### TM30: 92.2

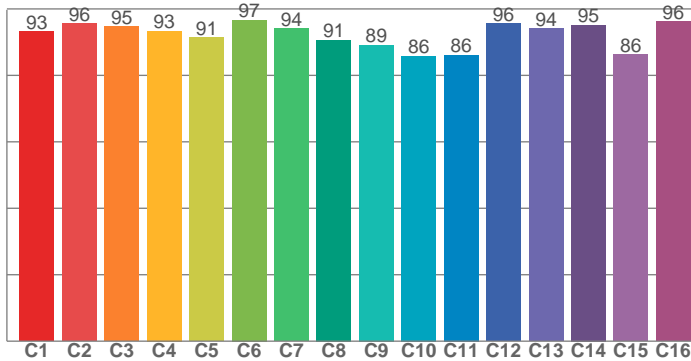

#### CRI: 96.7 (R1-R8)

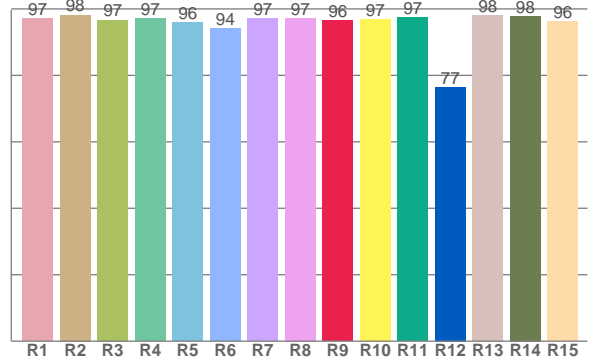

#### CRI R values, only R1-R8 are used to calculate final CRI value

R1	R2	R3	R4	R5	R6	R7	R8	R9	R10	R11	R12	R13	R14	R15
97.1	98.2	96.7	97.2	96.0	94.1	97.0	97.3	96.4	97.0	97.5	76.5	98.2	97.9	96.2

#### TM30 C Values, 16 binned values out of total of 99 C values

C1	C2	C3	C4	C5	C6	C7	C8	C9	C10	C11	C12	C13	C14	C15	C16
93.2	95.7	94.7	93.3	91.3	96.7	94.1	90.6	89.2	85.8	86.1	95.6	94.0	95.1	86.3	96.3

#### CQS Q Values

Q1	Q2	Q3	Q4	Q5	Q6	Q7	Q8	Q9	Q10	Q11	Q12	Q13	Q14	Q15
94.8	99.5	87.9	85.3	89.9	93.6	97.3	98.0	97.0	95.6	93.8	94.3	95.3	96.9	96.4

#### CQS: 93.2

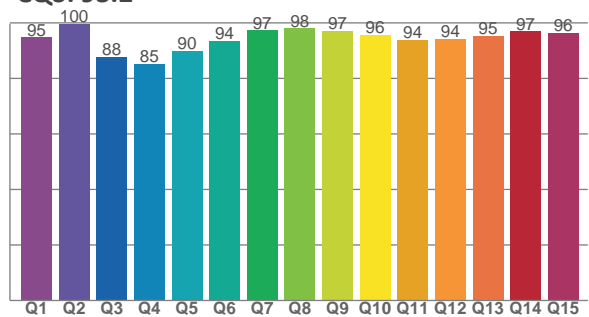

### Color Parameters

Color Temperature	Color Rendering Index	Red Component	Color Fidelity	Color Gamut	Color Quality Scale	Color Coordinate CIE 1931	Color Coordinate CIE 1931	Color Coordinate	Color Coordinate	Color Diviation from Black
CCT	CRI	CRI R9	TM30 Rf	TM30 Rg	CQS	x	y	u	v	Δuv
5702 K	96.7	96.4	92.2	99.7	93.2	0.328	0.334	0.207	0.315	-0.0052

TM30 Details

**Rf 92.2**  
Fidelity Index Rf

**Rg 99.7**  
Gamut Index Rg

Hue Bin	R <sub>f</sub>	Graphic shifts (%)	
		Chroma	Hue
1	93	-2%	1%
2	96	0%	2%
3	95	0%	1%
4	93	-2%	0%
5	91	-4%	0%
6	97	-1%	0%
7	94	-3%	2%
8	91	-3%	5%
9	89	-2%	10%
10	86	0%	9%
11	86	4%	8%
12	96	3%	1%
13	94	4%	-1%
14	95	1%	-1%
15	86	8%	-8%
16	96	-1%	0%

