



eNODE 4™ user manual

©2020 ELATION PROFESSIONAL all rights reserved. Information, specifications, diagrams, images, and instructions herein are subject to change without notice. ELATION PROFESSIONAL logo and identifying product names and numbers herein are trademarks of ELATION PROFESSIONAL. Copyright protection claimed includes all forms and matters of copyrightable materials and information now allowed by statutory or judicial law or hereinafter granted. Product names used in this document may be trademarks or registered trademarks of their respective companies and are hereby acknowledged. All non-ELATION brands and product names are trademarks or registered trademarks of their respective companies. Misalignment

ELATION PROFESSIONAL and all affiliated companies hereby disclaim any and all liabilities for property, equipment, building, and electrical damages, injuries to any persons, and direct or indirect economic loss associated with the use or reliance of any information contained within this document, and/or as a result of the improper, unsafe, insufficient and negligent assembly, installation, rigging, and operation of this product.

Elation Professional USA | 6122 S. Eastern Ave. | Los Angeles, CA. 90040
323-582-3322 | 323-832-9142 fax | www.elationlighting.com | info@elationlighting.com

Elation Professional B.V. | Junostraat 2 | 6468 EW Kerkrade, The Netherlands
+31 45 546 85 66 | +31 45 546 85 96 fax | www.elationlighting.eu | info@elationlighting.eu

Elation Professional Mexico | AV Santa Ana 30 | Parque Industrial Lerma, Lerma, Mexico 52000
+52 (728) 282-7070

DOCUMENT VERSION



Due to additional product features and/or enhancements, an updated version of this document may be available online. Please scan the QR Code with your mobile device or visit www.elationlighting.com for the latest revision/update of this manual, before installation and/or programming.

Date	Document Version	Software Version \geq	Notes
02/12/18	2	1.6	Updated release. Supports Art-Net 4 and sACN protocols.
03/12/18	3	2.2	Added different Sub-Net Mask options.
07/11/18	4	2.3	Added adjustable MAC address setting.
03/12/20	5	2.5	Added Network out to System Menu

CONTENTS

General Information	4
Warranty	5
Safety Instructions and Guidelines	6
Overview	7
Installation	8
System Menu	9
Setting DMX Ports	14
Technical Specifications	15
Optional Accessories	17

GENERAL INFORMATION

INTRODUCTION

Please read and understand the instructions in this manual carefully and thoroughly before attempting to operate this device. These instructions contain important safety and use information.

UNPACKING

Every device has been thoroughly tested and has been shipped in perfect operating condition. Carefully check the shipping carton for damage that may have occurred during shipping. If the carton is damaged, carefully inspect the device for damage, and be sure all accessories necessary to install and operate the device have arrived intact. In the event damage has been found or parts are missing, please contact our customer support team for further instructions. Please do not return this device to your dealer without first contacting customer support. Please do not discard the shipping carton in the trash. Please recycle whenever possible.

BOX CONTENTS

Fresnel Lens (installed)
Omega Brackets (x2)
Locking Power Cable

CUSTOMER SUPPORT

Contact **ELATION Service** for any product related service and support needs. Also visit forums.elationlighting.com with questions, comments or suggestions.

ELATION SERVICE USA - Monday - Friday 8:00am to 4:30pm PST
323-582-3322 | Fax 323-832-9142 | support@elationlighting.com

ELATION SERVICE EUROPE - Monday - Friday 08:30 to 17:00 CET
+31 45 546 85 63 | Fax +31 45 546 85 96 | support@elationlighting.eu

REPLACEMENT PARTS please visit parts.elationlighting.com



I M P O R T A N T N O T I C E !

THERE ARE NO USER SERVICEABLE PARTS INSIDE THIS UNIT.

DO NOT ATTEMPT ANY REPAIRS YOURSELF; DOING SO WILL VOID YOUR MANUFACTURES WARRANTY. DAMAGES RESULTING FROM MODIFICATIONS TO THIS FIXTURE AND/OR THE DISREGARD OF SAFETY INSTRUCTIONS AND GUIDELINES IN THIS MANUAL VOID THE MANUFACTURES WARRANTY AND ARE NOT SUBJECT TO ANY WARRANTY CLAIMS AND/OR REPAIRS.

LIMITED WARRANTY (USA ONLY)

A. Elation Professional hereby warrants, to the original purchaser, Elation Professional products to be free of manufacturing defects in material and workmanship for a period of two years (730 days), and Elation Professional product rechargeable batteries to be free of manufacturing defects in material and workmanship for a period of six months (180 days), from the original date of purchase. This warranty excludes discharge lamps and all product accessories. This warranty shall be valid only if the product is purchased within the United States of America, including possessions and territories. It is the owner's responsibility to establish the date and place of purchase by acceptable evidence, at the time service is sought. B. For warranty service, send the product only to the Elation Professional factory. All shipping charges must be pre-paid. If the requested repairs or service (including parts replacement) are within the terms of this warranty, Elation Professional will pay return shipping charges only to a designated point within the United States. If any product is sent, it must be shipped in its original package and packaging material. No accessories should be shipped with the product. If any accessories are shipped with the product, Elation Professional shall have no liability what-so-ever for loss and/or or damage to any such accessories, nor for the safe return thereof. C. This warranty is void if the product serial number and/or labels are altered or removed; if the product is modified in any manner which Elation Professional concludes, after inspection, affects the reliability of the product; if the product has been repaired or serviced by anyone other than the Elation Professional factory unless prior written authorization was issued to purchaser by Elation Professional; if the product is damaged because not properly maintained as set forth in the product instructions, guidelines and/or user manual. D. This is not a service contract, and this warranty does not include any maintenance, cleaning or periodic check-up. During the periods as specified above, Elation Professional will replace defective parts at its expense, and will absorb all expenses for warranty service and repair labor by reason of defects in material or workmanship. The sole responsibility of Elation Professional under this warranty shall be limited to the repair of the product, or replacement thereof, including parts, at the sole discretion of Elation Professional. All products covered by this warranty were manufactured after January 1, 1990, and bare identifying marks to that effect. E. Elation Professional reserves the right to make changes in design and/or performance improvements upon its products without any obligation to include these changes in any products theretofore manufactured. F. No warranty, whether expressed or implied, is given or made with respect to any accessory supplied with the products described above. Except to the extent prohibited by applicable law, all implied warranties made by Elation Professional in connection with this product, including warranties of merchantability or fitness, are limited in duration to the warranty periods set forth above. And no warranties, whether expressed or implied, including warranties of merchantability or fitness, shall apply to this product after said periods have expired. The consumer's and/or dealer's sole remedy shall be such repair or replacement as is expressly provided above; and under no circumstances shall Elation Professional be liable for any loss and/or damage, direct and/or consequential, arising out of the use of, and/or the inability to use, this product. G. This warranty is the only written warranty applicable to Elation Professional products and supersedes all prior warranties and written descriptions of warranty terms and conditions heretofore published.

WARRANTY RETURNS

All returned service items whether under warranty or not, must be freight pre-paid and accompany a return authorization (R.A.) number. The R.A. number must be clearly written on the outside of the return package. A brief description of the problem as well as the R.A. number must also be written down on a piece of paper and included in the shipping container. If the unit is under warranty, you must provide a copy of your proof of purchase invoice. Items returned without a R.A. number clearly marked on the outside of the package will be refused and returned at customer's expense. You may obtain a R.A. number by contacting customer support.

SAFETY GUIDELINES

This device is a sophisticated piece of electronic equipment. To guarantee a smooth operation, it is important to follow all instructions and guidelines in this manual. Elation Professional is not responsible for injury and/or damages resulting from the misuse of this device due to the disregard of the information printed in this manual. Only qualified and/or certified personnel should perform installation of this device and only the original rigging parts included with this device should be used for installation. Any modifications to the fixture and/or the included mounting hardware will void the original manufactures warranty and increase the risk of damage and/or personal injury.



PROTECTION CLASS 1 - DEVICE MUST BE PROPERLY GROUNDED ELECTRICAL CONNECTIONS BY QUALIFIED PERSONNEL ONLY!



THERE ARE NO USER SERVICEABLE PARTS INSIDE THIS UNIT. DO NOT ATTEMPT ANY REPAIRS YOURSELF; DOING SO WILL VOID YOUR MANUFACTURES WARRANTY. DAMAGES RESULTING FROM MODIFICATIONS TO THIS DEVICE AND/OR THE DISREGARD OF SAFETY INSTRUCTIONS AND GUIDELINES IN THIS MANUAL VOID THE MANUFACTURES WARRANTY AND ARE NOT SUBJECT TO ANY WARRANTY CLAIMS AND/OR REPAIRS.



**DO NOT PLUG DEVICE INTO A DIMMER PACK!
NEVER OPEN THIS DEVICE WHILE IN USE!
DO NOT EXPOSE DEVICE TO HEAT OR FIRE!
DO NOT EXPOSE DEVICE TO HIGH HUMIDITY!
AMBIENT TEMPERATURES: MAX 45°C/113°F | MIN 2°C/35°F
UNPLUG POWER BEFORE SERVICING DEVICE!
DO NOT EXPOSE DEVICE TO FLAMMABLE MATERIALS!
DO NOT EXPOSE DEVICE TO EXTREME VIBRATIONS!
KEEP FLAMMABLE MATERIALS AWAY FROM FIXTURE!**



**INDOOR / DRY LOCATIONS USE ONLY!
DO NOT EXPOSE DEVICE TO RAIN AND MOISTURE!**

DO NOT shake device, avoid brute force when installing and/or operating.

DO NOT operate device if the power cord has become frayed, crimped, damaged and/or if any of the power cord connectors are damaged and do not insert into the device securely with ease. **NEVER** force a power cord connector into the device. If the power cord or any of its connectors are damaged, replace it immediately with a new one of similar power rating.

DO NOT block any air ventilation slots. All fan and air inlets must remain clean and never blocked. Always disconnect device from main power source before performing any type of service and/or cleaning procedure. Only handle the power cord by the plug end, never pull out the plug by tugging the wire portion of the cord.

Use the original packaging and materials to transport the device in for service.

OVERVIEW

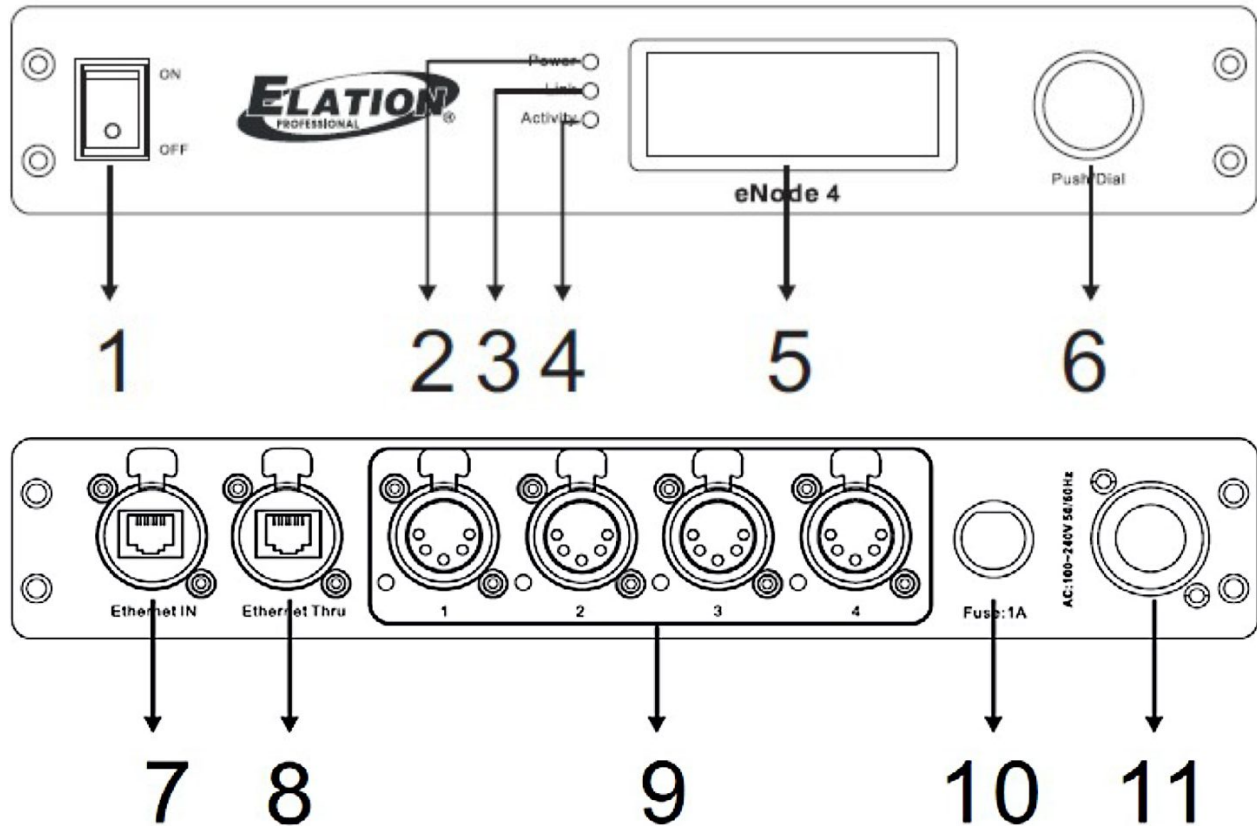

1. Power Switch (On/Off)
2. Power ON LED Indicator
3. Network Link LED Indicator
4. Network Activity LED Indicator
5. LCD Control Menu Display
6. Encoder Wheel
7. RJ45 Ethernet Input
8. RJ45 Ethernet Thru Output
9. 5pin DMX Assignable Input or Output Ports 1-4 (with LED indicators)
10. Fuse
11. Locking Power Cable Input



INCLUDED ITEMS

Power Cable

INCLUDED ITEMS

Power Cable

INSTALLATION

	FLAMMABLE MATERIAL WARNING Keep device at least 5.0 feet (1.5m) away from any flammable materials, decorations, pyrotechnics, etc.
	ELECTRICAL CONNECTIONS A qualified electrician should be used for all electrical connections and/or installations.

DO NOT INSTALL THE DEVICE IF YOU ARE NOT QUALIFIED TO DO SO!

DO NOT CONNECT DEVICE TO A CIRCULAR NETWORK! DOING SO WILL ADVERSELY IMPACT THE PERFORMANCE OF THE ENTIRE NETWORK SYSTEM!

Device **MUST** be installed following all local, national, and country commercial electrical and construction codes and regulations.

Ambient operating temperature range for this device is **35° to 113°F. (2° to 45°C)**

DO NOT use the device under or above this temperature range.

DO NOT install the device in areas where unauthorized personnel might reach the device.

MINI OMEGA BRACKET / CLAMP INSTALLATION

To attach device to truss, connect the included Mini Omega Bracket to the bottom of device and secure both thumb screws. Attach a properly rated clamp (not included) to the Mini Omega Bracket and attached device to truss.

INSTALLATION LOCATION ON TRUSS MUST BE CLEAR OF ANY MOVING HEAD FIXTURES!

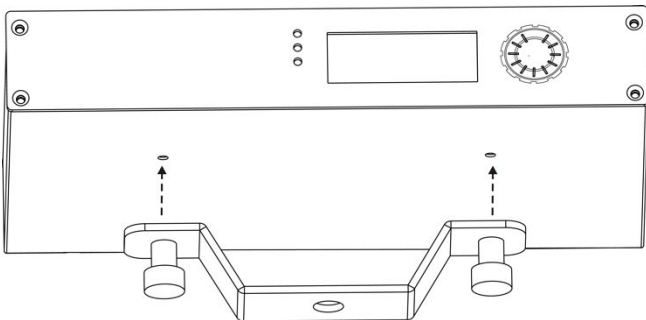

SYSTEM MENU

The LCD control panel display located on the front of the device provides access to the main system menus where all necessary system adjustments are made to the device. Pressing the **ENCODER WHEEL** once will access the main system menus. Rotate the **ENCODER WHEEL** clockwise or counterclockwise to scroll through the different system menus then push the **ENCODER WHEEL** to select a desired menu. Rotate the **ENCODER WHEEL** clockwise or counterclockwise to navigate the available setting options for each sub-menu. Setting changes are made using a combination of rotating and pushing the **ENCODER WHEEL**.

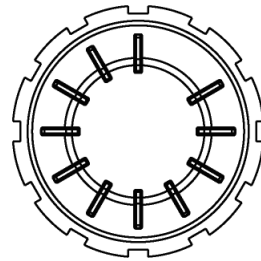
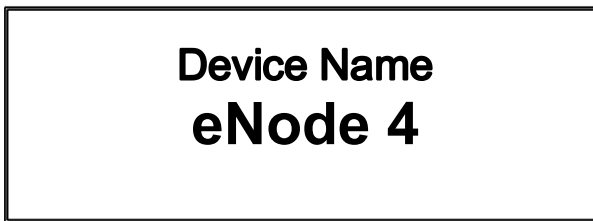

STARTUP VIEWS

There are four status screens which will display when the device is connected to a power source. Rotate the **ENCODER WHEEL** to scroll through the screens.

Device Name

This displays the current name (16 characters max)

Device Name eNode 4

MAC Address **(ONLY VISIBLE WITH Version 2.3)**

This displays the current MAC Address

Press and hold **ENCODER WHEEL** for 3 seconds to change MAC Address.

MAC Address 96:78:31:37:32:33

IP Address

This displays the current IP Address

IP Address 002.010.010.002

Device ID

This displays the current Device ID

Device ID 001

Port Status

This displays the status of each port (**A/B = Network Ports | 1-8 DMX Ports**)

Port Status									
A	B	1	2	3	4	5	6	7	8
x	x	x	x	x	x	x	x	x	x

- O** = **DMX Output**
- I** = **DMX Input**
- ✓** = **Network Active**
- ×** = **Network Inactive**
- H** = **Hold**
- B** = **Blackout**
- = **Null**

ELATION eNode 4 SYSTEM MENU

Features subject to change without any prior written notice.

Supports Software Version: ≥ V1.6

MAIN MENU	SUB MENU	OPTIONS / VALUES (Default Settings in BOLD)	DESCRIPTION	
1.Rename Device	Rename	eNode 4	Select 1-16 Characters to Rename Device	
2.Set IP Address	IP Address	002.010.010.002	Set Device IP Address Each IP Address MUST be unique	
3.Set Netmask	Netmask	A. 255.000.000.000	Select Netmask Address	
		B. 255.255.000.000		
		C. 255.255.255.000		
4.Set DMX Port	1.DMX Port1 2.DMX Port2 3.DMX Port3 4.DMX Port4 5.Exit	1.Port Status	Output , Input, Disabled	Select DMX Port Status
		2.Port Mode	Single , HTP, LTP, Backup, RDM, zero	Select DMX Port Mode RDM not supported in this software release
		3.Framertf/fs	040 , 010, 015, 020, 025, 030, 035	Select DMX Frame Rate Only available for PORT STATUS = OUTPUT
		4.Net	001 - 128	Set Sub Net
		5.Principal	001 -256	Set Principal Universe
		6.Secondary	009 , 001-256	Set Secondary Universe
		7.Resend	Disabled , 001-256	Enable Resend
		8.DMX State	Hold , Null, Blackout	Set How Connected Devices React to a Loss of DMX Signal
		9.Display Mode	Dec/256 , Hex/F.F	Select Binary or Hex Display Mode
		10.Exit		Exit Set DMX Port Menu
5.Set ID NO.	Device ID	001 , 000-255	Select Device ID	
6.Set LCD Backlight	LCD Backlight	1.ON	Backlight Stays ON Always	
		2.OFF	Backlight Auto Turns OFF After 30 Seconds	
7.User Preset	User Preset	1.4 X Input	8 Ports DMX IN	
		2.DMX Split 1-3	1 Port=DMX IN and 3 Ports=DMX OUT	
		3.ArtNet Clone	Art-Net IN Ports 1-2, Clone Art-Net OUT Ports 3-4	
		4.Isolated mode	NO DMX Input Signals Passed to Any Outputs	
		5.Output HTP	Highest Takes Precedence	
		6.Output LTP	Lowest Takes Precedence	
		7.Output Backup	Backup Mode	
		8.Factory Settings	Reset All Settings to Factory Default NOTE: ALL SETTINGS RESET TO DEFAULT!	
		9.Exit	Exit User Preset Menu	
8.Version	Version	V1.x	Software Versions	
9.Exit			Exit Main Menu	

ELATION eNode 4 SYSTEM MENU

Features subject to change without any prior written notice.

Supports Software Version: ≥ V2.5

MAIN MENU	SUB MENU	OPTIONS / VALUES (Default Settings in BOLD)	DESCRIPTION
1.Rename Device	Rename	eNode 4	Select 1-16 Characters to Rename Device
2.Set IP Address	IP Address	002.010.010.002	Set Device IP Address Each IP Address MUST be unique
3.Set Netmask	Netmask	Class A	255.000.000.000
			255.128.000.000
			255.192.000.000
			255.224.000.000
			255.240.000.000
			255.248.000.000
			255.252.000.000
			255.254.000.000
		Class B	255.255.000.000
			255.255.128.000
			255.255.192.000
			255.255.224.000
			255.255.240.000
			255.255.248.000
			255.255.252.000
			255.255.254.000
		Class C	255.255.255.000
			255.255.255.128
			255.255.255.192
			255.255.255.224
			255.255.255.240
255.255.255.248			
255.255.255.252			
4.Set DMX Port	1.DMX Port1 2.DMX Port2 3.DMX Port3 4.DMX Port4 5.Exit	1.Port Status	Output , Input, Disabled
		2.Port Mode	Single, HTP, LTP, Backup, RDM, zero
		2.Port Mode	Normal , Backup
		2.Port Mode	Single, HTP, LTP, Backup, RDM, normal, zero
		3. Framertf/fs	040 , 010, 015, 020, 025, 030, 035
		4.Net	001 - 128
		5.Principal	001 -256
		6.Secondary	009 , 001-256
		7.Resend	Disabled , 001-256
		8.DMX State	Hold , Null, Blackout
9.Display Mode	Dec/256 , Hex/F.F		
10.Exit	Exit Set DMX Port Menu		

ELATION eNode 4 SYSTEM MENU

Features subject to change without any prior written notice.

Supports Software Version: ≥ V2.5

MAIN MENU	SUB MENU	OPTIONS / VALUES (Default Settings in BOLD)	DESCRIPTION
5. Network out	ArtNet sACN		Select between ArtNet and sACN
6. Set ID NO.	Device ID	001 , 000-255	Select Device ID
7. Set LCD Backlight	LCD Backlight	1.ON	Backlight Stays ON Always
		2.OFF	Backlight Auto Turns OFF After 30 Seconds
8. User Preset	User Preset	1.4 X Input	8 Ports DMX IN
		2.DMX Split 1-3	1 Port=DMX IN and 3 Ports=DMX OUT
		4.ArtNet Clone	Art-Net IN Ports 1-2, Clone Art-Net OUT Ports 3-4
		5.Isolated mode	NO DMX Input Signals Passed to Any Outputs
		6.Output HTP	Highest Takes Precedence
		7.Output LTP	Lowest Takes Precedence
		8.Output Backup	Backup Mode
		9.Factory Settings	Reset All Settings to Factory Default NOTE: ALL SETTINGS RESET TO DEFAULT!
		10.Exit	Exit User Preset Menu
		9. Version	Version
10. Exit			Exit Main Menu

SETTING DMX PORTS

PORT STATUS

INPUT - Any of the (8) ports can be set as INPUT. When a port is set as INPUT, only the principle universe is available, and the PORT MODE can set to NORMAL or BACKUP.

OUTPUT - Any of the (8) ports can be set as OUTPUT. The PORT MODE can be set to

DISABLED - Disables selected Port and will not send or receive any data.

▶All Port Mode options can be selected for a Disabled Port; however, none will function.

PORT MODES

NORMAL [ONLY available when Port Status = INPUT]

Selected DMX Port will send any valid DMX data to the network (and internal use) using the selected Art-Net Universe.

BACKUP [ONLY available when Port Status = INPUT]

Selected DMX Port will not send any data if the selected Art-Net Universe is present on the network. If the selected universe becomes unavailable for several seconds and there is valid DMX input data present, the device will send the DMX data until data from the selected Art-Net Universe begins sending data again.

SINGLE [ONLY available when Port Status = OUTPUT]

Sets selected Port to send the DMX values of the selected Principle Art-NET Universe.

DMX output is enabled the first time it detects the DMX universe on the network or DMX data input.

HTP (Highest Takes Precedence) [ONLY when Port Status = OUTPUT]

Selected Port merges data from the Principle and Secondary Universes and outputs the one with the higher value.

▶Can only be selected for DMX Ports with a Port Status = OUTPUT

▶**Make sure RESEND option in System Menu is NOT set to Disabled or data will not be sent to the network.**

LTP (Latest Takes Precedence) [ONLY when Port Status = OUTPUT]

Selected Port outputs the latest channel activity from the Principle and Secondary Universes on a channel-by-channel basis.

▶Can only be selected for DMX Ports with a Port Status = OUTPUT

▶**Make sure RESEND option in System Menu is NOT set to Disabled or data will not be sent to the network.**

RDM (Remote Device Management) [ONLY when Port Status = OUTPUT]

ZERO [ONLY when Port Status = OUTPUT]

Selected DMX Port sends a DMX test signal with all channels at 0%.

TECHNICAL SPECIFICATIONS

CONTROL / CONNECTIONS

4-Universes

Art-Net, sACN, and RDM Compatible DMX Control Systems

DMX Bilateral Conversion

sACN Auto-Detection

Auto MDI/MDIX

DMX Splitter Function (1 Input / 3 Outputs)

Broadcast Mode (One Device Transmits Same Signal to Other Connected Devices)

Backup Mode

Push Button Configuration Encoder Wheel

LCD Control Menu Display & LED Indicators

(2) RJ45 Ethernet TCP/IP 10/100M Inputs

(4) Universal 5pin DMX Ports (can be set as Input or Output)

Locking Power In

SIZE / WEIGHT

Length: 10.0" (255mm)

Width: 6.8" (173mm)

Vertical Height: 1.7" (43mm)

Weight: 3.5 lbs. (1.6kg)

ELECTRICAL / THERMAL

AC 100-240V - 50/60Hz

5W Max Power Consumption

35.6°F (2°C) to 113°F (45°C)

APPROVALS / RATINGS



DIMENSIONAL DRAWINGS

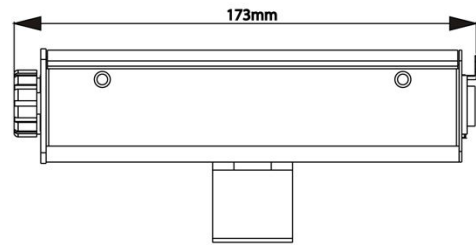
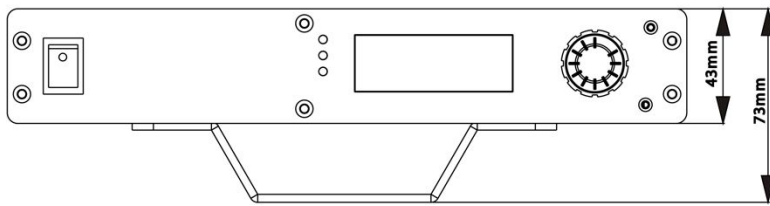
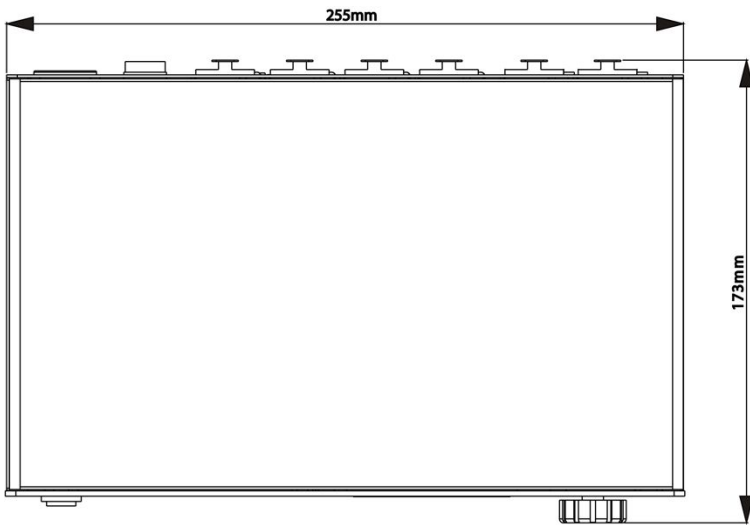

Specifications and improvements in the design of this unit and this manual are subject to change without any prior written notice.

OPTIONAL ACCESSORIES

ORDER CODE	ITEM
NARROW CLAMP	Heavy Duty 2-inch Clamp
CAT005	5 ft. (1.5m) CAT6 Ethernet PRO Cable
AC5PDMX5PRO	5 ft. (1.5m) 5pin PRO DMX Cable
-o	Additional Cable Lengths Available

