

DLED STRIP RGBAW

Elation Professional™
6122 S. Eastern Ave.
Los Angeles, Ca 90040
www.elationlighting.com

TABLE OF CONTENTS

| | | |
|-----|--------------------------------------|----|
| 1. | General Information..... | 3 |
| | a. Introduction..... | 3 |
| | b. Unpacking..... | 3 |
| | c. Customer Support..... | 3 |
| | d. Warranty Registration..... | 4 |
| 2. | Safety Instructions..... | 5 |
| 3. | Features..... | 7 |
| 4. | General Guidelines..... | 8 |
| 5. | Fixture Overview..... | 9 |
| 6. | Mounting and Installation..... | 11 |
| 7. | Understanding DMX..... | 14 |
| | a. DMX Cables..... | 14 |
| | b. DMX Terminator..... | 16 |
| | c. 3-Pin to 5-Pin Conversion..... | 17 |
| | d. Fixture DMX Addressing..... | 17 |
| 8. | Display Indicators..... | 19 |
| 9. | Display Menu..... | 20 |
| 10. | DMX Addressing..... | 28 |
| | a. Remote DMX Addressing (RDMX)..... | 28 |
| 11. | DMX Traits..... | 30 |
| 12. | Working with Built-In programs..... | 40 |
| 13. | User manual of RF controller..... | 43 |
| 14. | Lens Replacement..... | 45 |
| 15. | Cleaning and Maintenance..... | 46 |
| 16. | Warranty..... | 47 |
| 17. | Photometric Data..... | 49 |
| 18. | Dimensional Drawings..... | 50 |
| 19. | Circuit Schematic..... | 51 |
| 20. | Technical Specifications..... | 52 |

1. GENERAL INFORMATION

INTRODUCTION: Congratulations, you have just purchased one of the most innovative and reliable LED fixtures on the market today! The DLED STRIP RGBAW™ has been designed to perform reliably for years when the guidelines in this booklet are followed. Please read and understand the instructions in this manual carefully and thoroughly before attempting to operate this unit. These instructions contain important information regarding safety during use and maintenance.

UNPACKING: Thank you for purchasing the DLED STRIP RGBAW™ by Elation Professional®. Every DLED STRIP RGBAW™ has been thoroughly tested and has been shipped in perfect operating condition. Carefully check the shipping carton for damage that may have occurred during shipping. If the carton appears to be damaged, carefully inspect your fixture for damage and be sure all accessories necessary to operate the fixture have arrived intact. In the event damage has been found or parts are missing, please contact our customer support team for further instructions. Inside the box you should find: the fixture, a DMX XLR cable, a safety cable, and this manual. Please do not return this unit to your dealer without first contacting customer support at the number listed below.

RF Controller is the optional accessories, please purchase from your local dealer if needed.

CUSTOMER SUPPORT: Elation Professional® provides a customer support line, to provide set up help and to answer any question should you encounter problems during your set up or initial operation. You may also visit us on the web at www.elationlighting.com for any comments or suggestions. For service related issue please contact Elation Professional®. Service Hours are Monday through Friday 9:00 a.m. to 5:00 p.m. Pacific Standard Time.

Voice: (323) 582-3322

Fax: (323) 832-9142

E-mail: support@elationlighting.com

Forum: www.ElationLighting.com/forum

Warning! To prevent the risk of fire and reduce the risk electrical shock, do not attempt to

operate this fixture with the lens cover removed.

Caution! There are no user serviceable parts inside this unit. Do not attempt any repairs yourself. Doing so will void your manufacturer's warranty.

Please do not discard the shipping carton in the trash. Please recycle whenever possible.

WARRANTY REGISTRATION: The DLED STRIP RGBAW™ carries a two-year (730 days) limited warranty. Please fill out the enclosed warranty card to validate your purchase. All returned service items whether under warranty or not, must be freight pre-paid and accompany a return authorization (R.A.) number. The R.A. number must be clearly written on the outside of the return package. A brief description of the problem as well as the R.A. number must also be written down on a piece of paper and included in the shipping container. If the unit is under warranty, you must provide a copy of your proof of purchase invoice. Items returned without a R.A. number clearly marked on the outside of the package will be refused and returned at customer's expense. You may obtain a R.A. number by contacting customer support at (323) 582-3322.

2. SAFETY INSTRUCTIONS



To guarantee proper and consistent operation, it is important to follow the guidelines in this manual. Elation Professional will not accept responsibility for damages resulting from the misuse of this fixture due to the disregard of the information printed in this manual.

1. Always be sure that the fan and the air inlets remain clean and are never blocked. Allow about 6" (15cm) between this fixture and other devices or a wall to allow for proper cooling. See page 12.
2. Never touch the fixture during normal operation.
3. Never look directly into the light source. You risk injury to your retina, which may induce blindness.
4. For safe operation, follow the Installation guide described in chapter six of this manual. Operating the DLED STRIP RGBAW™ without suited safety aids such as safety cables or clamps can increase the risk of damage and/or personal injury.
5. Qualified and certified personnel should only perform installation.
6. When mounting this fixture, use only the original rigging points included with this fixture. Any structural modification will void the original manufacturer's warranty and may increase the risk of damage and/or personal injury.
7. Do not attempt to operate this fixture if the power cord has become damaged or frayed.
8. **Never open this fixture while in use.**
9. This device falls under protection-class I. Therefore it is essential that the device be grounded properly.
10. Qualified personnel should perform all electrical connections.
11. Be sure the available voltage matches the voltage requirements of the unit. Be sure the power cord is never crimped or damaged. If the power cord is

damaged, replace it immediately with a new one of similar power rating.

12. Always disconnect from main power before performing any type of service or any cleaning procedure.
13. Only handle the power cord by the plug. Never pull out the plug by tugging the wire portion of the cord.
14. ***Please be aware that damages caused by modifications to the device are not subject to warranty.***

Important Notice: Damages resulting from the disregard of safety and general user instructions found in this user manual are not subject to any warranty claims.

3. FEATURES

- Low power consumption
- Minimal heat emission
- Maintenance free operation
- Equipped with 75 1-Watt (15 x red, 15 x green, 15 x blue, 15 x white, 15 x amber)
- Silent Operation, convection cooled
- 100,000 hours **rated** LED life
- Linear RGBWA Color Mixing, infinite color possibilities
- 35° Beam Angle/62° Field Angle (25° Lens)
- USITT DMX-512 Complaint
- Preprogrammed colored macros
- Strobe-effect with a maximum flash rate of 18fps
- DMX-controlled operation or stand-alone operation with Master/Slave-function
- 8 built-in programs can be called up via DMX-controller
 - ~ 48 preprogrammed scenes per program
- Sound-controlled via built-in microphone
- Five DMX Modes:
 - 28 DMX channels
 - 25 DMX channels
 - 9 DMX channels
 - 6 DMX channels
 - 5 DMX channels (default)
- DMX-control via standard DMX-controller
- Upgradable firmware via Elation “E-Loader” Data Pack
- Electronic Switching Power Supply 100V~240V
- Flicker-free operation for television and film
- Compact design: fits in 12” box truss
- 0%~100% Dimming (two dimming options; linear & standard)

4. GENERAL GUIDELINES

This fixture is a professional lighting effect designed for use on stage, in nightclubs, in theatres, and other types of architectural installations. Do not attempt operation or installation without a proper knowledge on how to do so.

Consistent operational breaks will ensure that the fixture will function properly for many years to come.

Do not shake the fixture around. Avoid brute force when installing or operating the fixture.

While choosing an installation location, please be sure that the fixture will not be exposed to extreme heat, moisture, or dust. The minimum distance between the fixture and a wall or flat surface should be at least 0.1 meter (about 4ft). See page 12.

Always install the fixture with an appropriately rated safety cable. When installing the fixture in a suspended environment always be sure to use mounting hardware no less than M10 x 25 mm, also be sure the hardware is only inserted in the yoke's mounting holes.

Do not attempt to operate this fixture until you have familiarized yourself with all of its functions.

Do not permit operation by persons not qualified for operating this type of architectural fixture. Most damages are the result of improper operation.

Please use the original packaging to transport the fixture in for service.

For your own safety, please read this user manual carefully before installing the device.

5. FIXTURE OVERVIEW

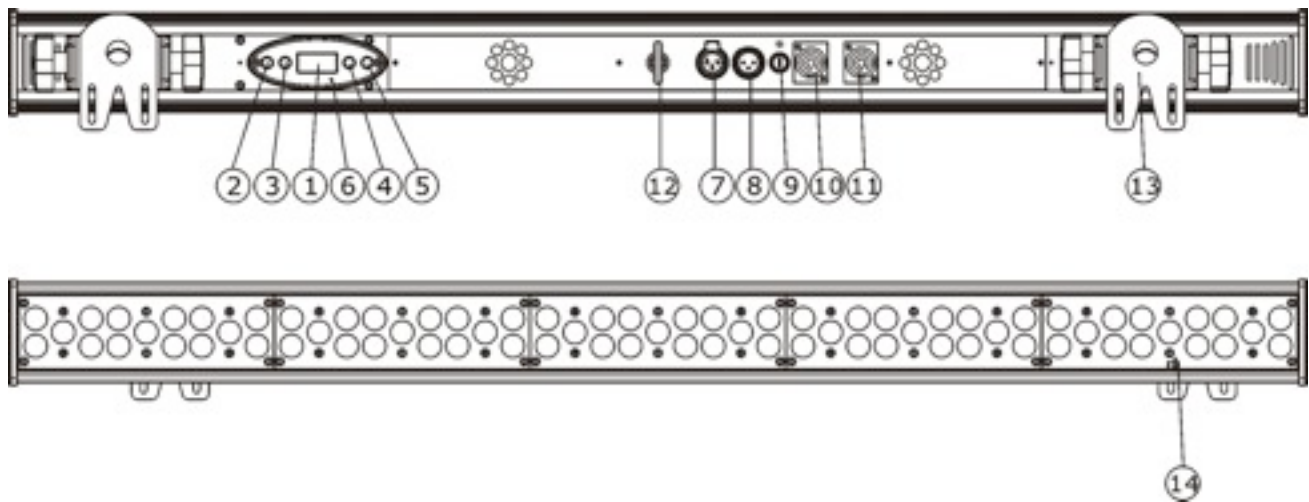

1. **LED Display** – 4-segment menu display. Used to display the DMX address as well as all other menu functions.
2. **Mode/Esc Button** – This button is used to access the fixtures menu functions.
3. **Up Button** – The up button is used to toggle forward through the menu functions and settings.
4. **Down Button** – The down button is used to toggle backwards through the menu functions and settings.
5. **Enter Button** – The enter button is used to enter in to a certain menu function or to lock a menu setting in to memory.
6. **Microphone** – This microphone receives external low frequencies to trigger the unit in Sound-Active mode. This microphone is designed to receive low frequency sounds only, tapping on the microphone and high pitch sounds may not trigger the unit.

7. **3-Pin DMX Output Jack** – This jack is used to send an incoming DMX signal to the next fixture in the DMX chain via a female, 3-pin XLR jack.
8. **3-PIN DMX Input Jack** – This jack accepts an incoming DMX signal via a male, 3-pin XLR jack.
9. **Fuse Holder Assembly** – This assembly houses the 3.15 amp GMA safety fuse. Always replace the fuse with an exact match unless otherwise specified by an authorized Elation Service Technician. Using a fuse other than that specified could seriously damage the unit and will void your manufactures warranty.
10. **Power Output Lead** – This lead is used to jump power to another DLED STRIP RGBAW™. Please do not daisy chain power for more than 6 fixtures. only use proper Elation IP rated power cables.
11. **Main Power Input Lead** – This lead is the main power input lead. When the unit is the first in a chain or the only fixture to be used, be sure to use the power starter cable that converts a standard Edison 3-prong to the rated twist lock connector.

6. MOUNTING AND INSTALLATION

Cautions:

For added protection mount the fixtures in areas outside walking paths, seating areas, and away from areas where unauthorized personnel might reach the fixture.

Before mounting the fixture to any surface, make sure that the installation area can hold a minimum point load of 10 times the device's weight.

Fixture installation must always be secured with a secondary safety attachment, such as an appropriate safety cable.

To avoid injury, never stand directly below the device when mounting, removing, or servicing the fixture.

| | |
|---|---|
|  | Refer to regulations BGV C1 (formerly VBG 70) and DIN VDE0711-217 for proper installation in Europe To ensure proper installation, only qualified staff should attempt installation. |
|---|---|

Mounting points

Overhead mounting requires extensive experience, including amongst others calculating working load limits, a fine knowledge of the installation material being used, and periodic safety inspection of all installation material and the fixture. If you lack these qualifications, do not attempt the installation yourself. Improper installation can result in bodily injury.

| | |
|---|--|
|  | CAUTION! Be sure a qualified electrician performs all electrical connections. |
|---|--|

Be sure to complete all rigging and installation procedures before connecting the main power cord to the appropriate wall outlet.

Mounting

The DLED STRIP RGBAW™ is fully operational in any mounting position, hanging upside-down, side mounted, or set on a flat level surface, etc. Be sure this fixture is kept at least 0.5m (1.5 feet) away from any flammable materials (decoration etc.). When clamp mounting; always use and install the supplied safety cable as an added safety measure to prevent accidental damage in the event of a clamp failure. **See the image below.**

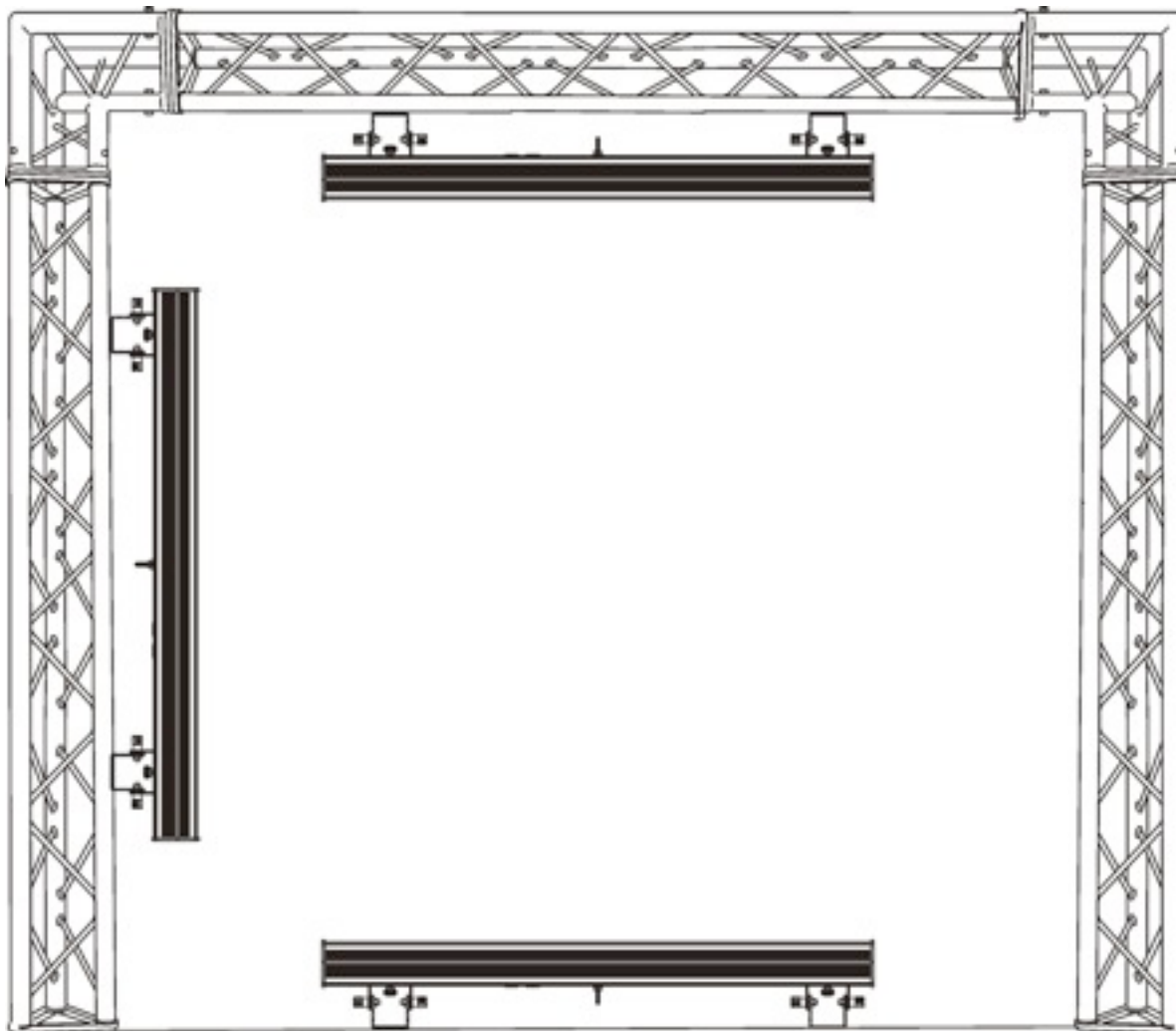

Clamp Mounting

The DLED STRIP RGBAW™ provides a unique mounting bracket assembly that allows the unit to stand on a flat surface or to be hung on truss via a clamp in any safe position (see the illustration above). Regardless of the mounting option you choose please be sure to refer to the safety guidelines in this manual to avoid damage to the unit and/or personal injury.

When mounting this fixture to truss be sure to secure an appropriately rated clamp to the hanging yoke using a M10 screw fitted through the center hole of the hanging yoke. As an added safety measure be sure to attach at least one properly rated safety cable to the fixture. See illustrations below.

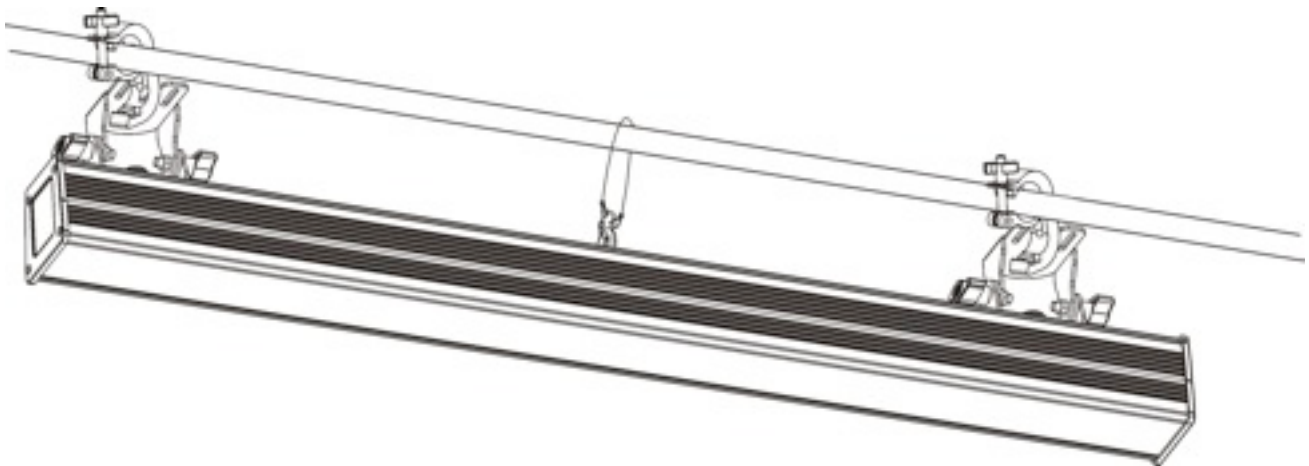

Securing the DLED STRIP RGBAW™



Always be sure to secure your fixture with a safety cable when suspending the unit from truss or other means. The fixture provides a built-in rigging point for a safety cable as illustrated above. Be sure to only use the designated rigging point for the safety cable and never secure a safety cable to the hanging bracket.

7. UNDERSTANDING DMX

DMX-512: DMX is short for Digital Multiplex. This is a universal protocol used by most lighting and controller manufactures as a form of communication between intelligent fixtures and controllers. DMX allows all makes and models of different manufactures to be linked together and operate from a single controller. This is possible as long as all the fixtures and the controller are DMX compliant. A DMX controller sends the DMX data instructions to a fixture allowing the user to control the different aspects of an intelligent light. DMX data is sent out as serial data that travels from fixture to fixture via data “IN” and “OUT” leads located on the fixtures (most controllers will only have output jacks).

DMX Linking: To ensure proper DMX data transmission, always use proper DMX cables and a terminator. When using several DMX fixtures try to use the shortest cable path possible. Never split a DMX line with a “Y” style connector. The order in which the fixtures are connected in a DMX line does not influence the DMX addressing. For example; a fixture assigned a DMX address of 1 may be placed anywhere in the DMX chain, at the beginning, at the end, or anywhere in the middle. The DMX controller knows to send data assigned to address 1 to that fixture no matter where it is located in the DMX chain. The DLED STRIP RGBAW™ can be controlled via DMX-512 protocol. The DLED STRIP RGBAW™ is a fixture that can operate in 5, 6, 9, 25 or 28 DMX channels (see pages 30-39 for the different DMX traits). The DMX address is set electronically using the controls on the LED menu.



Note: Although microphone and DMX cables may look similar, they are not constructed of the same material and should never be used in place of each other.

Data Cable (DMX Cable) Requirements (For DMX and Master/Slave Operation): Your fixture and your DMX controller require a standard 3-pin or 5-pin XLR connector for data input and data output (the illustration on the next page is of a 3-Pin XLR connector). If you are making your own cables, be sure to use two conductor shielded digital DMX cable rated at 120 ohms, this cable is designed for DMX transmission and may be purchased from your Elation dealer or at most professional lighting retailers. Your cables should be made with a

male and female XLR connector on either end of the cable. Also, remember that a DMX line must be daisy chained and cannot be split, unless using an approved DMX splitter

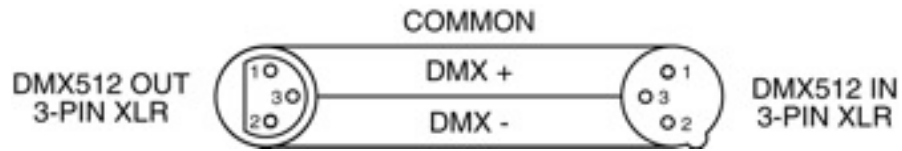

Be sure to follow the above figure when making your own cables. Do not use the ground lug on the XLR connector. Do not connect the cable's shield conductor to the ground lug or allow the shield conductor to come in contact with the XLR's outer casing. Grounding the shield could cause a short circuit and erratic behavior.

DMX-output
XLR mounting-socket

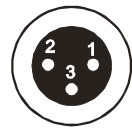

1:Ground
2:Signal(-)
3:Signal(+)

DMX-input
XLR mounting-socket



1:Ground
2:Signal(-)
3:Signal(+)

DMX-512 control connection

Connect an XLR cable to the female XLR output of your controller and the other side to the male XLR input of the fixture (Please refer to the diagram below.). You can chain multiple moving heads together through serial linking. Remember to daisy-chain the “in” and “out” data connections.

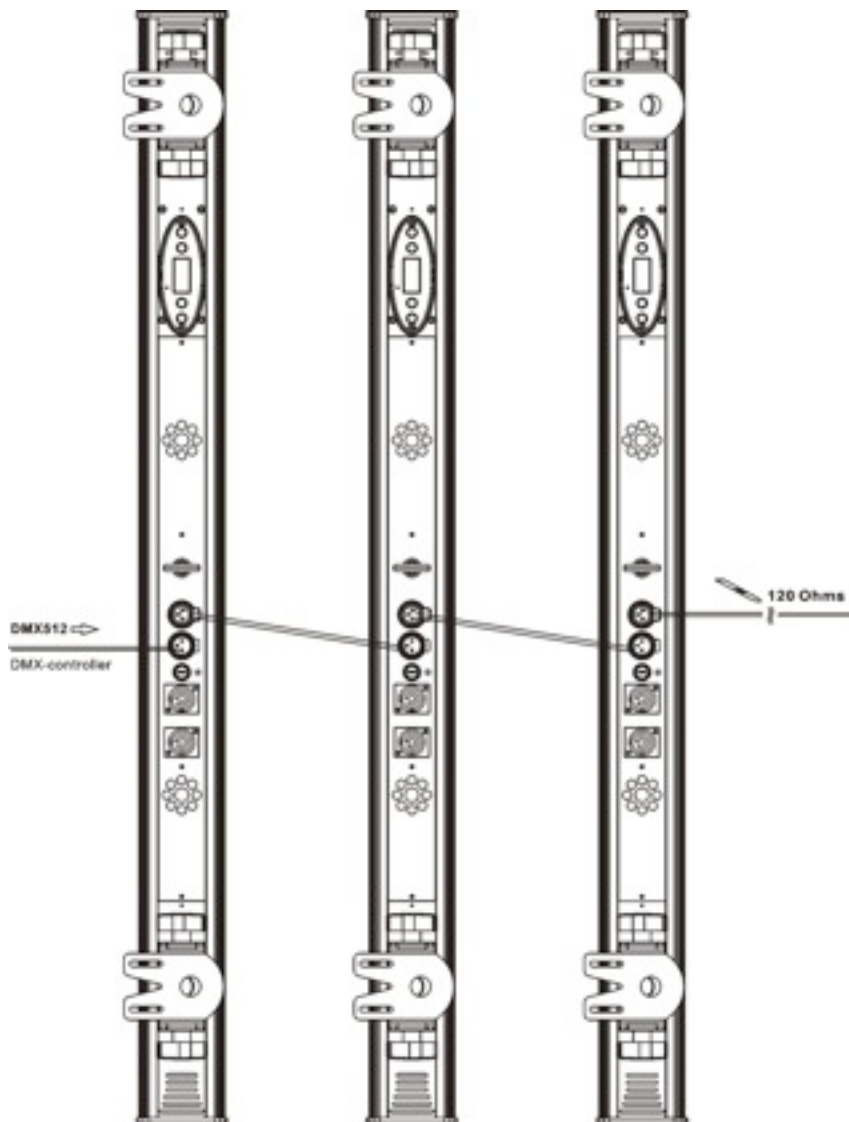
**DMX-512 connection with DMX terminator**

A DMX terminator should be used in all DMX lines especially in longer runs. The use of a terminator may avoid erratic behavior in your DMX line. A terminator is a 120 ohm 1/4 watt

resistor that is connected between pins 2 and 3 of a male XLR connector (DATA + and DATA -). This fixture is inserted in the female XLR connector of the last fixture in your daisy chain to terminate the line. Using a *line terminator (Elation part: DMX T PACK)* will decrease the possibilities of erratic behavior.

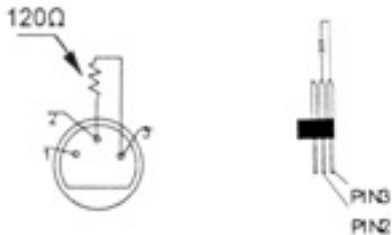

Termination reduces signal errors and avoids signal transmission problems and interference. It is always advisable to connect a DMX terminal, (Resistance 120 Ohm 1/4 W) between PIN 2 (DMX-) and PIN 3 (DMX +) of the last fixture.

5-Pin XLR DMX Connectors. Some manufactures use 5-pin XLR connectors for DATA transmission in place of 3-pin. 5-pin XLR fixtures may be implemented in a 3-pin XLR DMX line. When inserting standard 5-pin XLR connectors in to a 3-pin line a cable adaptor must be used, these adaptors are readily available at most electric stores. The following chart details a proper cable conversion.

| 3-Pin XLR to 5-Pin XLR Conversion | | |
|-----------------------------------|------------------------|---------------------|
| Conductor | 3-Pin XLR Female (Out) | 5-Pin XLR Male (In) |
| Ground/Shield | Pin 1 | Pin 1 |
| Data Compliment (- signal) | Pin 2 | Pin 2 |
| Data True (+ signal) | Pin 3 | Pin 3 |
| Not Used | | Pin 4 - Do Not Use |
| Not Used | | Pin 5 - Do Not Use |

Fixture DMX addressing;

All fixtures should be given a DMX starting address when using a DMX controller, so the correct fixture responds to the correct control signal. This digital starting address is the channel number from which the fixture starts to “listen” to the digital control information sent out from the DMX controller. The allocation of this starting DMX address is achieved by

setting the correct DMX address on the digital display located on the back of the fixture.

You can set the same starting address for all fixtures or a group of fixtures, or set different address for each individual fixture. Be advised that setting all your fixtures to the same DMX address will subsequently control all fixtures in the same fashion, in other words, changing the settings of one channel will affect all the fixtures simultaneously.

If you set each fixture to a different DMX address, each unit will start to “listen” to the channel number you have set, based on the quantity of control channels (DMX channels) of each fixture. That means changing the settings of one channel will only affect the selected fixture.

In the case of the DLED STRIP RGBAW™, which is up to a five channel fixture, you should set the starting DMX address of the first unit to 1, the second unit to 6 (5 + 1), the third unit to 11 (5 + 6), and so on.

Note: During start-up the DLED STRIP RGBAW™ will automatically detect whether a DMX data signal is being received or not. If a DMX data signal is being received, the display will show "**A.XXX**" (**XXX** representing the actual DMX address). If the fixture is not receiving a DMX signal the display will flash "**A.XXX**" (**XXX** representing the actual DMX address).

If your fixture is connected to a DMX controller and the display is flashing (not receiving a DMX signal), please check the following:

- The 3-pin or 5-pin XLR plug (cable with DMX signal from controller) may not be connected or is not inserted completely into the DMX input jack.
- The DMX controller is switched off or defective.
- The DMX cable from the controller merging with included IP Rated Cable adapter is not connected securely
- The DMX cable or connector is defective.
- A DMX terminator has been inserted into the last fixture in your DMX chain.

8. DISPLAY LED INDICATOR.

The DLED STRIP RGBAW™ has a LED indicator on the display. This indicator is designed to give a quick visual indication of the fixtures' DMX status. The illustration below details the functionality of the LED indicators.

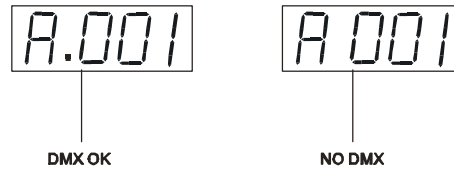

The LED indicator represents DMX signal:

- If the indicators is on, a clean DMX signal is present
- If the indicator is off, there is no DMX signal present

9. DISPLAY MENU

Default settings shaded.

| | | | | | |
|------|-------------------|-----------------------|---|--|--------------------------|
| MODE | <ADDR> | VALU | A001~AXXX (AXXX) | DMX address setting | |
| | | SLAV | ON/OFF | Set as Slave | |
| | | RDMX | ON/OFF | Change address via DMX | |
| | <RUN> | AUTO | ALON/MAST | Run Auto program | |
| | | SOUN | ALON/MAST | Run sond program | |
| | <DISP> | VALU | D-XX D-00(DXXX) | Display DMX value | |
| | | FLIP | ON/OFF | Flip display | |
| | | D ON | ON/OFF | Delay shutting off LED display | |
| LOCK | | ON/OFF | Key lock (Press the MENU button for 3 seconds to activate) | | |
| SET | <CHAN> | 5CH/6CH/9CH/25CH/28CH | | DMX channel Mode | |
| | <FAIL> | OFF/HOLD/AUTO/AUDI | | Status while there is no DMX | |
| | <MIC> | M-XX M-70 | | Mic sensitivity | |
| | <DIMR> | DIM1/ DIM2/DIM3/DIM4 | | Set dimmer mode (DIM1 to DIM4 dimmer fast to slow) | |
| | <FANS> | AUTO/HIGH/LOW | | Fan's mode select | |
| | <POHO> | ON/OFF | | Power on to preserve the MANL settings | |
| | <DFSE> | ON/OFF | | Default setting | |
| | <VER> | V-1.0~V-9.9 | | Software version | |
| MANL | RED | RXXX (0-255) | | Manual adjust intensity Manual adjust intensity. | |
| | GREN | GXXX (0-255) | | | |
| | BLUE | BXXX (0-255) | | | |
| | WHIT | WXXX (0-255) | | | |
| | AMBE | AXXX (0-255) | | | |
| | PROG | PXXX (0-255) | | | |
| | STRB | SXXX (0-255) | | | |
| | DIMM | DXXX (0-255) | | | |
| TIME | <LIFE> | 0000~9999(HOURS) | | Life time of machina running | |
| | <CODE> | CXXX | | Passord of clear time "038" | |
| | <CLFE> | ON/OFF | | Clear machina running time | |
| EDIT | <STEP> | S-01~S-48 | | Select steps of program | |
| | REC. | RE.XX | | Auto Save Scene | |
| | <SC01> ~<SC48> | RED | RXXX (0-255) | | Edit the internal scenes |
| | | GREN | GXXX (0-255) | | |
| | | BLUE | BXXX (0-255) | | |
| | | WHIT | WXXX (0-255) | | |
| | | AMBE | AXXX (0-255) | | |
| | | PROG | PXXX (0-255) | | |
| STRB | | SXXX (0-255) | | | |
| DIMM | DXXX (0-255) | | | | |

| | | | |
|--|------|-----------------|-----------------------------|
| | FADE | XXX | |
| | | X X X . X | |
| | TIME | (000.1S~999.9S) | |
| | CEDT | ON/OFF | Edit program via controller |

9.1 “MODE” - Function Mode:

9.1.1 <ADDR> - DMX address setting – This function is used to set or adjust the fixture’s starting DMX address. Every device controlled by DMX has to have a unique starting address. The addressing feature is what allows DMX to function properly. The DMX address of a fixture is what allows it to communicate with a controller properly. The DMX addressing also allows the fixture to ignore any DMX information coming from the controller that is not meant specifically for the fixture. Because each fixture is connected in a daisy-chain fashion it is imperative to assign a proper and unique starting DMX address to each and every fixture. The DMX address is non-destructive and will remain in the fixture’s memory even when the power to the unit is switched off. Memory is backed-up and retain by an internal power source that should last about five years. For proper DMX addressing see “DMX Addressing” on page 28 of this user manual.

“VALU” - Display the DMX 512 value of each channel

With this function you can display the DMX 512 value of each channel. The display will automatically detail the changing DMX values as they are received from the controller.

“SLAV” - Slave setting for Master/Slave Operation

With this function, you can define the device as slave for operation in Master/Slave mode. Each slave setting will have a different function for a dynamic lightshow without a controller.

“RDMX” - Address via DMX - This function allows the DMX address to remotely be adjusted from a DMX console. This setting requires special settings for both the controller and the fixture. RDMX is on by default. For operational instructions please

see Section 10/Page 28 of this manual “Remote DMX addressing.”

9.1.2 <RUN> - Internal Program Settings

This function allows the internal programs to run in either stand-alone or master/slave mode. In “Master” mode the fixture will send DMX data to other fixtures connect via the DMX chain. In “Alone” mode the fixture will operate as a single fixture. The program for this mode is selected in the “**Select program**” section of the control menu. You can set the number of steps under “**Edit program**”. You can edit the individual scenes under “**Edit scenes**”. With this function, you can run the individual scenes either automatically, i.e. with the adjusted Step-Time.

9.1.3 <DISP> - Menu Display Settings

This function allows the internal programs to run in either stand-alone or master/slave DMX chain. In “Alone” mode

“VALU” - Display the DMX 512 value of each channel

This function will electronically display the current DMX value for any channel that is currently being adjusted. The display will automatically detail the changing DMX values as they are received from the controller. This function is “off” by default.

“**FLIP**” – This function will flip the display readout by a 180° allowing for better visualization when the fixture is mounted in an inverted position.

“**D ON**” – The display is designed to turn off during normal operation to avoid excessive light in situations that require an extremely dark environment. This function will adjust the time delay the fixture will remain on before it turns off. ***This function is disabled as default.***

LOCK – This function allows you to lock the keys.

With this function you can activate the automatic keylock status. If this function is

activated, the keys will be automatically locked in 15 seconds from the last press. In order to deactivate the keylock status, press the Mode/Esc-button for 3 seconds.

1. Access the main menu.
2. Tap the UP button until “DISP” is displayed.
3. Press ENTER, the display will show “VALU”.
4. Tap the UP button until ”LOCK” is displayed and tap the ENTER button.
5. Press the UP button to select “ON” to activate this function, or “OFF” to deactivate this function.
6. Press ENTER to confirm.
7. Press MENU to return to the main menu.

9.2 “SET” – Fixture Personality Settings:

These functions set specific running modes and operating parameters.

<CHAN> DMX Mode settings

This function allows the fixture to run in different DMX channel modes. Five modes are available; 5 channel, 6 channel, 9 channel, 25 channel or 28 channel. See “DMX Traits” beginning on page 30~ page 39 for a detailed explanation of the different DMX modes.

<FAIL> DMX Fault Protection

This function dictates how the fixture will operate in the event DMX signal is suddenly lost while operating in DMX mode. The three fail safe modes are; 1) “OFF” which will blackout all light output. 2) “HOLD,” which will hold the last DMX command, 3) “AUTO,” which will put the fixture in sound-active mode. or 4) “Audi”, The fixture will go into sound-active mode.

<MIC> Mic sensitivity

This function allows for electronic control of the internal microphone’s sound sensitivity.

<DIMR> - Set dimmer mode

With this function you can Set dimmer mode.

<FANS> Select the fan run mode

This function will choose between the fan settings of Auto, High, or Low. The default setting is Auto.

<POHO> - Power on to preserve the MANL settings

This function will preserve all the manual setting that are made in the “MANL” menu section. If this function is not activated all manual settings will be lost once the fixture is tuned off.

<DFSE> - Restore Default

This function is used to restore the factory settings of the device. All settings will be set back to the default values (shaded). Any edited scenes will be lost.

<VER> Software Version

This function will display the current firmware version.

9.3 “MANL” – Manual Fixture Settings:

This function allows the each of the five DMX channels to be controlled manually. This will allow the fixture to be preset to a specific color or built-in program without the use of a DMX console.

9.4 “TIME” – Operating Hours

These functions will detail different time functions associated with the fixture.

<LIFE> (0000~9999 Hours)

This function tracks the running time of the fixture from the point it was last cleared. Where “XXXX ”represents the total number of running hours. This time is none destructive and will remain in the fixtures memory indefinitely. Use this time to track rentals or show durations.

<CODE> Clear run time access code

This lock-out code prevents the current run time from being erased accidentally. The

access code is “038”

<CLFE> Clear Fixture Run Time

This function resets the run time to zero.

.5 “Edit” Internal Program Settings:

The fixture comes equipped with a built-in DMX recorder that allows custom programs to be installed and recalled directly from the fixture’s control board. Programs can be created and stored using the fixture’s control board or by using an external DMX controller. For detailed instructions on how to complete this task please see “Working with Built-In Programs” Section 12/ Page 40.

- .5.1 **Select program** – This function allows the user to select one of ten of the user defined built-in programs. This program is then accessed in “Function Mode” under “Program Run.”
- .5.2 **REC** – Auto save function.
- .5.3 **Edit program** – This function allows the user to edit the built-in programs.
- .5.4 **Edit Scenes** – This function allows the user to edit or define the actual scenes that are stored in the user defined built-in programs that are accessed in the previous step.
- .5.5 **CEDT** - Edit program using a external controller.

Editing procedure 1: Using the control board only.

1. Access the main menu.
2. Tap the UP button until “EDIT” is displayed and press ENTER.
3. The display will show “SC-01”, this stands for the scene number. For example, “SC-01” is displayed, it means you will be editing scene 1, press ENTER. You can change the scene number by tapping the UP button.
4. Press ENTER, the display will show “C-01,” this represents the channel number. If “C-01” is displayed, you will be editing the fixture’s channel 1 value of the

selected scene, press ENTER. You can change the channel number by tapping the UP button.

5. The display will show the DMX value for the channel that is being edited. It will be displayed as "11XX," it stands for Channel 11 of the editing scene, the DMX value is "XX."
6. Adjust the DMX value by tapping the UP button, until you get the expected effect for this channel.
7. Press ENTER to enter the editing of the other channels of the scene.
8. Repeat steps 5-8, until you finish setting all the DMX values for all the channels of this scene, each scene can have 16 channels maximum.
9. Once all the channels are completed, the display will begin to flash "TIME," this indicates the time needed to run this scene.
10. Press ENTER to edit the time needed, the display shows "TXXX", "XXX" represents the time needed to run this scene. For example, "T002" means scene 1 needs 0.4 seconds to run, "T-15" means this scene needs 3.0 seconds to run. Note: "XX" is always 0.2 seconds not one second.
11. Adjust the time needed by tapping the UP button.
12. Press ENTER to save the settings for the scene you are editing, the display will change to the next scene automatically.
13. Repeat steps 3-12 to edit other scenes, you can edit and save 48 scenes maximum.
14. Press MODE/ESC to exit and save your edited scene into the fixtures internal memory. The number of steps can be defined under "EDIT" and the scenes can be called up under "Run." To run the scenes see page 30.

Editing procedure 2: Using an external controller.

1. Call up the first scene in your controller now.
2. Select "SC01" by pressing the UP or DOWN buttons.
3. Press MODE/ESC, the display shows "SC01".
4. Press MODE/ESC, the display shows "C-01".
5. Select "CEDT" by pressing the UP or DOWN buttons.
6. Press MODE/ESC, the display shows "OFF".

7. Press UP, the display will read "ON".
8. Press MODE/ESC, the display shows "SC02". You successfully downloaded the first scene.
9. Adjust the Step-time as described above.
10. Call up the second scene in your controller now.
11. Repeat steps 5-11 until all desired scenes are downloaded.
12. Press MODE/ESC to exit. The number of steps can be defined under "STEP" and the scenes can be called up under "RUN."

10. DMX ADDRESSING

Setting the DMX address - After the fixture is turned “ON” it will immediately complete a reset process that test all the fixture’s functions. When the reset process concludes the LED will display the fixture’s current DMX address. If the fixture is not receiving a DMX signal, the display will flash continuously. To set or adjust a DMX address, please follow the procedure below:

1. Toggle through the menu by pressing the Up and Down buttons until the display reads “Addr=XXX.” Tap the enter button to make changes to the address.
2. While the display is flashing use the “UP” and “DOWN” buttons to select a new address. Once the new address has been selected, lock the new address into the fixture’s memory by pressing the “ENTER” button.

The DMX address is non-volatile and will remain in the fixture’s memory even when the power to the unit is switched off. Memory is backed-up and retain by an internal power source that should last about five years

Remote DMX addressing (RDMX) / Address Via DMX- This function allows the DMX address to be changed remotely from a DMX console. This setting requires special settings for both the controller and the fixture. This function may be turned on and off, and is “ON” be default. Follow the procedure listed below to access the RDMX functions:

Fixture Settings:

1. Access the main menu and use the UP or DOWN to get to the “Personality” menu, then press ENTER
2. Once in the “Personalities” menu, tap the UP or Down to get to the “Status Settings “ menu, press ENTER.
3. Once in the “Status Settings” tap the UP or Down to get to the “Address via DMX” function and press ENTER.
4. “Address via DMX” is the function that turn the RDMX function on and off. Press ENTER and be sure the function is turned on.
5. Press the UP button to display “ON” to activate this function, or “OFF” to deactivate this function.

6. Press ENTER to confirm.
7. Press MODE/ESC to return to the main menu.

Controller Settings:

1. Set the DMX value of channel 1 to a value of 7.
2. Set the DMX value of channel 2 to a value of 7 or 8. When channel 2 is set to "7" you can adjust the starting address between 1 and 255. When set to "8" you can adjust the starting address between 256 and 511.
3. Use channel 3 to set your desired DMX starting address. **For example:** If you want to set the starting address to 57, set channel 1 to a value of "7," set channel 2 to a value of "7" and use channel 3 to set your address to 57 by selecting a channel value of 57. Example 2: If you want to set the starting address to 420, set channel 1 to a value of "7," channel 2 to "8" and channel 3 to "164" ($256+164=420$).
4. **Wait for approximately 20 seconds for the unit to complete the address reset function.**

11. DMX TRAITS

DMX Operation Notes:

The fixture will function in DMX mode whenever the unit is receiving a DMX signal. Please note that this will override all manual settings.

This unit will keep and retain the last DMX command in the event of DMX signal failure. To reset the fixture you must turn the power off.

DMX CHANNEL TRAITS

The charts below and on the preceding pages outline the different DMX traits for the five different DMX modes.

5-Channel mode: In this mode channel one controls all the red LEDs, channel two controls all the green LEDs, channels three controls all the blue LEDs, channel four controls all the white LEDs, and channel five controls all the amber LEDs.

5 Channel mode :

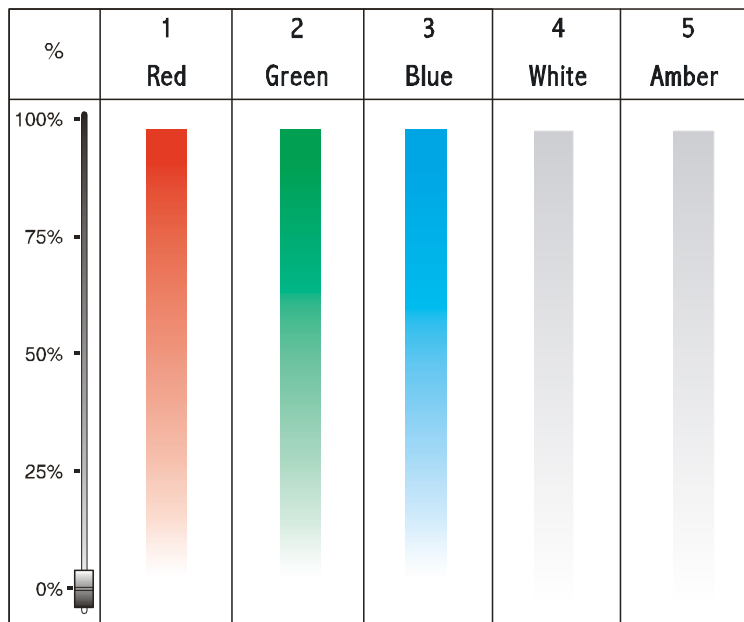

DMX channel's functions and their values (5-Channel Mode):**Channel 1 - Red:**

0-255 Red (0-Black, 255 - 100% Red)

Channel 2 - Green:

0-255 Green (0-Black, 255 - 100% Green)

Channel 3 - Blue:

0-255 Blue (0-Black, 255 - 100% Blue)

Channel 4 - White:

0-255 White (0-Black, 255 - 100% White)

Channel 5 - Amber:

0-255 Amber (0-Black, 255 - 100% Amber)

6-Channel mode: In this mode channel one controls all the red LEDs, channel two controls all the green LEDs, channels three controls all the blue LEDs, channels four controls all the white LEDs, channels five controls all the amber LEDs, and channel six will control the master dimming level.

6 Channel mode :

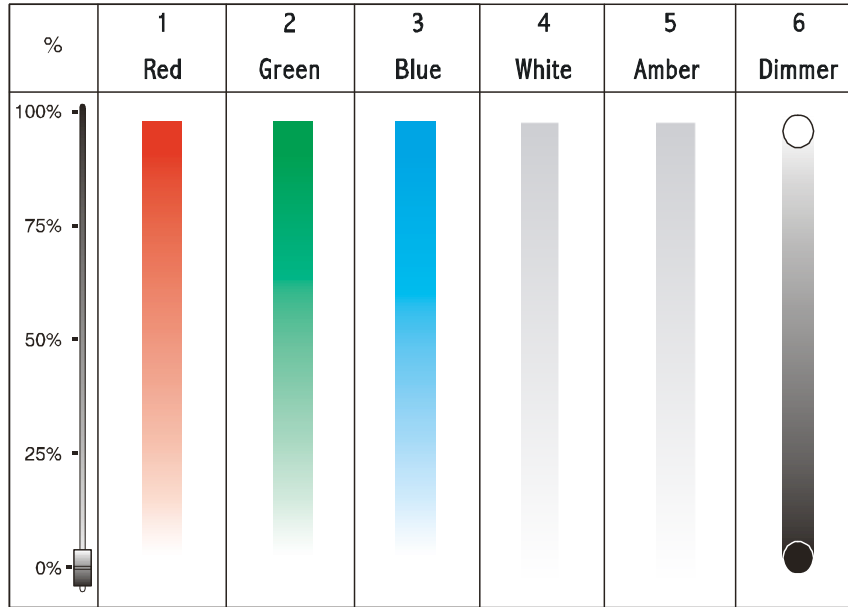

DMX channel's functions and their values (6-Channel Mode):

Channel 1 - Red:

0-255 Red (0-Black, 255 - 100% Red)

Channel 2 - Green:

0-255 Green (0-Black, 255 - 100% Green)

Channel 3 - Blue:

0-255 Blue (0-Black, 255 - 100% Blue)

Channel 4 - White:

0-255 White (0-Black, 255 - 100% White)

Channel 5 - Amber:

0-255 Amber (0-Black, 255 - 100% Amber)

Channel 6 - General dimming

0-255 Dimming (0-Black, 255- 100%)

9-Channel mode: In this mode channels 1~5 are used to control the RGBWA LEDs and

channels 6~9 will control special features. *9-Channel Mode*: The charts below and on the next page detail the DMX channel layout for 9-channel assignment.

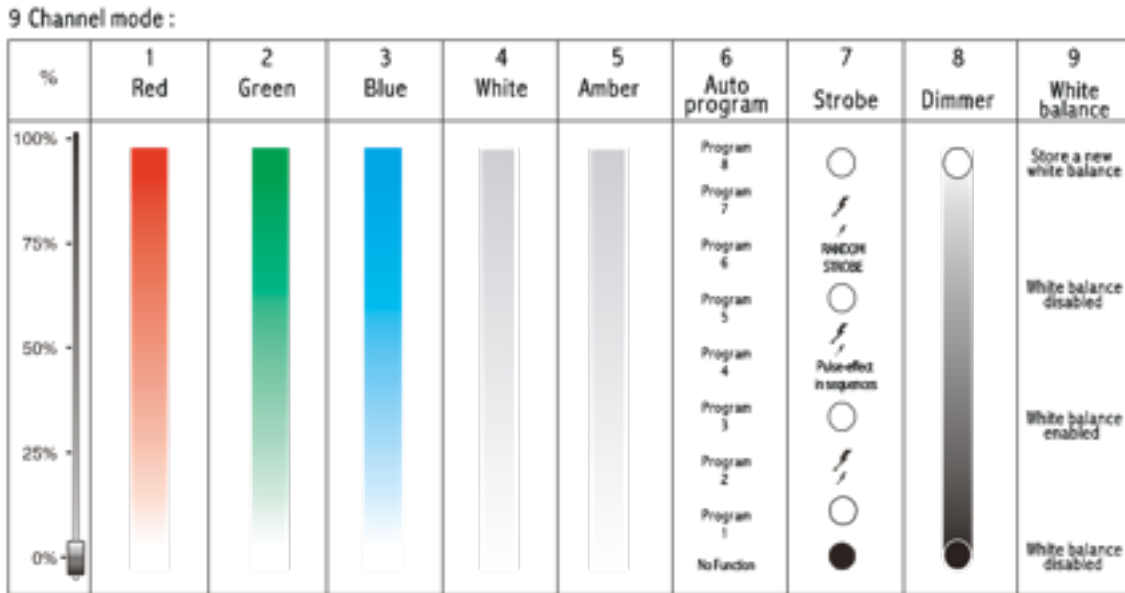

DMX channel's functions and their values (9-Channel Mode):

Channel 1 - Red:

| | |
|-------|----------------------------|
| 0-255 | Red (0-Black , 255-100%) |
| | |

Channel 2 - Green:

| | |
|-------|------------------------------|
| 0-255 | Green (0-Black , 255-100%) |
| | |

Channel 3 - Blue:

| | |
|-------|----------------------------|
| 0-255 | Blue(0-Black , 255-100%) |
| | |

Channel 4 - White:

| | |
|-------|------------------------------|
| 0-255 | White (0-Black , 255-100%) |
| | |

Channel 5 - Amber:

| | |
|-------|-----------------------------|
| 0-255 | Amber(0-Black , 255-100%) |
| | |

Channel 6 - internal program:

| | |
|-------|--------------------|
| 0-10 | No function |
| 11-40 | internal program 1 |
| 41-70 | internal program 2 |

| | |
|---------|--------------------|
| 71-100 | internal program 3 |
| 101-130 | internal program 4 |
| 131-160 | internal program 5 |
| 161-190 | internal program 6 |
| 191-220 | internal program 7 |
| 221-255 | internal program 8 |
| | |

Channel 7 - Shutter, strobe

| | |
|---------|-----------------------------------|
| 0-31 | No function (shutter close) |
| 32-63 | No function (shutter open) |
| 64-95 | Strobe effect slow to fast |
| 96-127 | No function (shutter open) |
| 128-159 | Pulse-effect in sequences |
| 160-191 | No function (shutter open) |
| 192-223 | Random strobe effect slow to fast |
| 230 | Store Color_mode enable |
| 224-255 | No function (shutter open) |
| | |

Channel 8 - General dimming/speed:

| | |
|-------|--------------------------------|
| 0-255 | Dimming(0-Black , 255- 100%) |
| | |

Channel 9 - White balance:

| | |
|---------|---------------------------|
| 0-63 | White balance disabled |
| 64-189 | White balance enabled |
| 190-250 | White balance disabled |
| 251-255 | Store a new white balance |

25-Channel mode: In this mode channels 1~25 are used to control the RGBWA LEDs .

25 Channel mode:

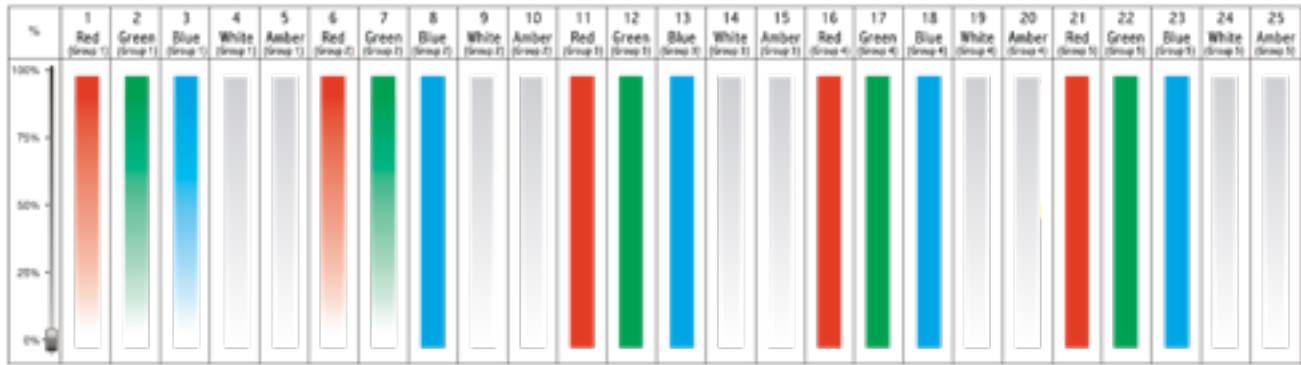

DMX channel's functions and their values (25-Channel Mode):

Channel 1 - Red LED:

0-255 Red (0-Black, 255-100% Red)

Channel 2 - Green LED:

0-255 Green (0-Black, 255-100% Green)

Channel 3 - Blue LED:

0-255 Blue (0-Black, 255-100% Blue)

Channel 4 - White LED:

0-255 White (0-Black, 255-100% White)

Channel 5 - Amber LED:

0-255 Amber (0-Black, 255-100% Amber)

Channel 6 - Red LED:

0-255 Red (0-Black, 255-100% Red)

Channel 7 - Green LED:

0-255 Green (0-Black, 255-100% Green)

Channel 8 - Blue LED:

0-255 Blue (0-Black, 255-100% Blue)

Channel 9 - White LED:

| | |
|---------------------------------------|---------------------------------|
| 0-255 | White (0-Black, 255-100% White) |
| <u>Channel 10 - Amber LED:</u> | |
| 0-255 | Amber (0-Black, 255-100% Amber) |
| <u>Channel 11 - Red LED:</u> | |
| 0-255 | Red (0-Black, 255-100% Red) |
| <u>Channel 12 - Green LED:</u> | |
| 0-255 | Green (0-Black, 255-100% Green) |
| <u>Channel 13 - Blue LED:</u> | |
| 0-255 | Blue (0-Black, 255-100% Blue) |
| <u>Channel 14 - White LED:</u> | |
| 0-255 | White (0-Black, 255-100% White) |
| <u>Channel 15 - Amber LED:</u> | |
| 0-255 | Amber (0-Black, 255-100% Amber) |
| <u>Channel 16 - Red LED:</u> | |
| 0-255 | Red (0-Black, 255-100% Red) |
| <u>Channel 17 - Green LED:</u> | |
| 0-255 | Green (0-Black, 255-100% Green) |
| <u>Channel 18 - Blue LED:</u> | |
| 0-255 | Blue (0-Black, 255-100% Blue) |
| <u>Channel 19 - White LED:</u> | |
| 0-255 | White (0-Black, 255-100% White) |
| <u>Channel 20 - Amber LED:</u> | |
| 0-255 | Amber (0-Black, 255-100% Amber) |
| <u>Channel 21 - Red LED:</u> | |
| 0-255 | Red (0-Black, 255-100% Red) |
| <u>Channel 22 - Green LED:</u> | |

| | |
|---------------------------------------|---------------------------------|
| 0-255 | Green (0-Black, 255-100% Green) |
| <u>Channel 23 - Blue LED:</u> | |
| 0-255 | Blue (0-Black, 255-100% Blue) |
| <u>Channel 24 - White LED:</u> | |
| 0-255 | White (0-Black, 255-100% White) |
| <u>Channel 25 - Amber LED:</u> | |
| 0-255 | Amber (0-Black, 255-100% Amber) |

28-Channel mode: In this mode channels 1~25 are used to control the RGBWA LEDs and channels 26~28 will control special features. *28-Channel Mode:* The charts below and on the next page detail the DMX channel layout for 28-channel assignment.

28Channel mode:

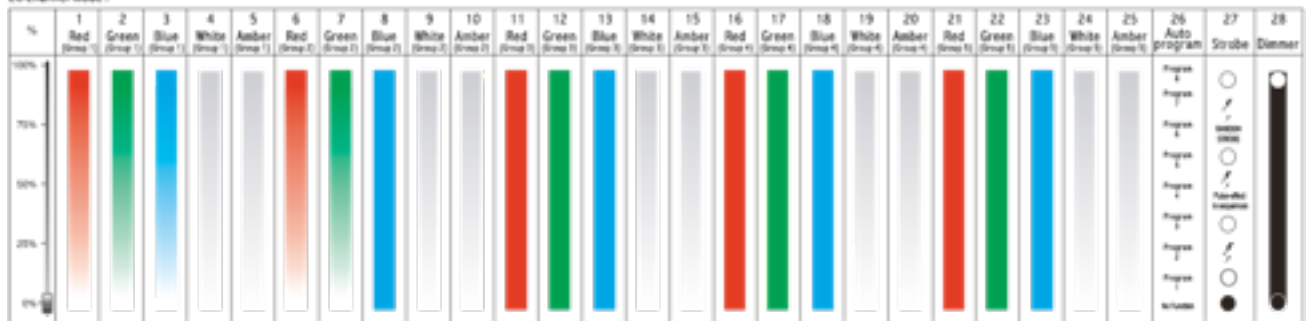

DMX channel's functions and their values (28-Channel Mode):

Channel 1 - Red LED:

| | |
|-------|-----------------------------|
| 0-255 | Red (0-Black, 255-100% Red) |
|-------|-----------------------------|

Channel 2 - Green LED:

| | |
|-------|---------------------------------|
| 0-255 | Green (0-Black, 255-100% Green) |
|-------|---------------------------------|

Channel 3 - Blue LED:

| | |
|-------|-------------------------------|
| 0-255 | Blue (0-Black, 255-100% Blue) |
|-------|-------------------------------|

Channel 4 - White LED:

| | |
|-------|---------------------------------|
| 0-255 | White (0-Black, 255-100% White) |
|-------|---------------------------------|

Channel 5 - Amber LED:

| | |
|-------|---------------------------------|
| 0-255 | Amber (0-Black, 255-100% Amber) |
| | |

Channel 6 - Red LED:

| | |
|-------|-----------------------------|
| 0-255 | Red (0-Black, 255-100% Red) |
| | |

Channel 7 - Green LED:

| | |
|-------|---------------------------------|
| 0-255 | Green (0-Black, 255-100% Green) |
| | |

Channel 8 - Blue LED:

| | |
|-------|-------------------------------|
| 0-255 | Blue (0-Black, 255-100% Blue) |
| | |

Channel 9 - White LED:

| | |
|-------|---------------------------------|
| 0-255 | White (0-Black, 255-100% White) |
| | |

Channel 10 - Amber LED:

| | |
|-------|---------------------------------|
| 0-255 | Amber (0-Black, 255-100% Amber) |
| | |

Channel 11 - Red LED:

| | |
|-------|-----------------------------|
| 0-255 | Red (0-Black, 255-100% Red) |
| | |

Channel 12 - Green LED:

| | |
|-------|---------------------------------|
| 0-255 | Green (0-Black, 255-100% Green) |
| | |

Channel 13 - Blue LED:

| | |
|-------|-------------------------------|
| 0-255 | Blue (0-Black, 255-100% Blue) |
| | |

Channel 14 - White LED:

| | |
|-------|---------------------------------|
| 0-255 | White (0-Black, 255-100% White) |
| | |

Channel 15 - Amber LED:

| | |
|-------|---------------------------------|
| 0-255 | Amber (0-Black, 255-100% Amber) |
| | |

Channel 16 - Red LED:

| | |
|-------|-----------------------------|
| 0-255 | Red (0-Black, 255-100% Red) |
| | |

Channel 17 - Green LED:

| | |
|-------|---------------------------------|
| 0-255 | Green (0-Black, 255-100% Green) |
|-------|---------------------------------|

| | |
|--|---------------------------------|
| <u>Channel 18 - Blue LED:</u> | |
| 0-255 | Blue (0-Black, 255-100% Blue) |
| <u>Channel 19 - White LED:</u> | |
| 0-255 | White (0-Black, 255-100% White) |
| <u>Channel 20 - Amber LED:</u> | |
| 0-255 | Amber (0-Black, 255-100% Amber) |
| <u>Channel 21 - Red LED:</u> | |
| 0-255 | Red (0-Black, 255-100% Red) |
| <u>Channel 22 - Green LED:</u> | |
| 0-255 | Green (0-Black, 255-100% Green) |
| <u>Channel 23 - Blue LED:</u> | |
| 0-255 | Blue (0-Black, 255-100% Blue) |
| <u>Channel 24 - White LED:</u> | |
| 0-255 | White (0-Black, 255-100% White) |
| <u>Channel 25 - Amber LED:</u> | |
| 0-255 | Amber (0-Black, 255-100% Amber) |
| <u>Channel 26 - internal program:</u> | |
| 0-10 | No function |
| 11-40 | internal program 1 |
| 41-70 | internal program 2 |
| 71-100 | internal program 3 |
| 101-130 | internal program 4 |
| 131-160 | internal program 5 |
| 161-190 | internal program 6 |
| 191-220 | internal program 7 |
| 221-255 | internal program 8 |

Channel 27 - Shutter, strobe:

| | |
|---------|-----------------------------------|
| 0-31 | No function (shutter close) |
| 32-63 | No function (shutter open) |
| 64-95 | Strobe effect slow to fast |
| 96-127 | No function (shutter open) |
| 128-159 | Pulse-effect in sequences |
| 160-191 | No function (shutter open) |
| 192-223 | Random strobe effect slow to fast |
| 230 | Store Color_mode enable |
| 224-255 | No function (shutter open) |
| | |

Channel 28 - General dimming/speed:

| | |
|-------|--------------------------------|
| 0-255 | Dimming(0-Black , 255- 100%) |
|-------|--------------------------------|

12. WORKING WITH BUILT-IN PROGRAMS

The fixture comes equipped with a built-in DMX recorder that allows custom programs to be installed and recalled directly from the fixture's control board. Programs can be created and stored using the fixture's control board or by using an external DMX controller. The following instructions will detail the procedures for using the on-board system menu as well as using a DMX compliant controller.

Memory Statistics:

Total Number of Programs: 1

Maximum Number of Steps (Scenes) per a Program: 48

Total Number of Scenes (Steps): 48

Creating a Program - The fixture will store a maximum of 48 scenes. These scenes are then used to create the program. A program can store one or a maximum of 48 steps. Keep in mind that a scene can only be access when it is stored the "Program." If you wish to build a static scene (a scene consisting of a single color), use the "Manual" function instead (see page XX). Building a program involves first setting the total amount of steps in the program (1-48) then creating the scenes. Keep in mind that although you can create a total of 48 unique scenes the program will only playback the total amount of steps that have been assigned to the program, i.e., If you create 36 unique scenes but define the total amount of steps in the program to three, the program will only playback the first three scenes.

Step 1 – Defining Amount of Steps.

The fixture will store a maximum of 48 steps per a program. These steps will consist of the scenes that will be created in "Step 2" below. Keep in mind that steps are not scenes only a definition of how many scenes will be played back in the program. To define the total amount of steps, follow the procedure below;

STEP - Define the number of steps in Run

1. Access the main menu and toggle to "Edit."

node - SET - NAME - LINE - Edit

2. Then tap the "ENTER" button and toggle to "STEP," menu function.

STEP

3. Tap the “ENTER” button to define the maximum amount of steps. Maximum amount of steps is 48. Steps will be indicated as “S-01” for a single step and “S-48” for 48 steps. Once you set the maximum amount of steps press enter to lock in the selection. Once the total amount of steps has been set advance to editing scenes.

Step 2 – Building Scenes.

The fixture will store a maximum of 48 scenes. These scenes are then used to create the programs. A program can store one or a maximum of 48 steps. To create a scene for playback follow the procedure below;

1. Access the main menu and toggle to “Edit.”

MODE - SET - NAME - TIME - Edit

2. Then tap the “ENTER” button and toggle to “SC-01,” menu function.

SC01

3. Tap the “ENTER” button to program scene one. Four functions can be edited per a scene; White, (LED level), Strobe (strobe level), Fade (fade time), and Time (hold time).
4. Toggle to the channel function that needs to be adjusted and press enter, then use the up and down buttons to adjust the DMX channel value.
5. Press **ENTER** to adjust the value to any remaining channels.
6. Repeat steps 3-5 until you finish setting all the DMX values for all channels of this scene.
7. Once all channel values have been set, the display will flash “**TIME**”
8. Press **ENTER** to edit the hold time. The display will indicate “**TXXX**”, where “**XXX**” defines the actual hold value in milliseconds by the power of two. The hold value can range from “001 to 999”. E.g., “002” means a hold time of 0.4ms (002*0.2ms). Use the Up and Down button to adjust the hold time and press enter when done.
9. Pressing **ENTER** to save the settings for the scene will lock in the setting and automatically advance to the next scene.
10. Repeat step 3-8 to edit and other scenes, you can edit and save a maximum of 48 scenes.

Step 3 – Playing a Program

To initiate a program follow the procedure below:

MODE - RUN - AUTO - ALON
 MODE - RUN - AUTO - ALON
 MODE - RUN - AUTO - ALON
 MODE - RUN - AUTO - ALON

- Access the main menu and use the “Up” and “Down” to toggle to “Mode” and tap the “Enter” button.
- In the next screen select “Run” and tap Enter.
- In the next screen toggle to “Auto” and tap enter. There are now two selections, “Master” and “Alone.” Select “Master” when running multiple fixtures in a master/slave configuration. Select “Alone” when running a single fixture or when multiple fixtures in stand-alone mode.

13. User manual of RF controller

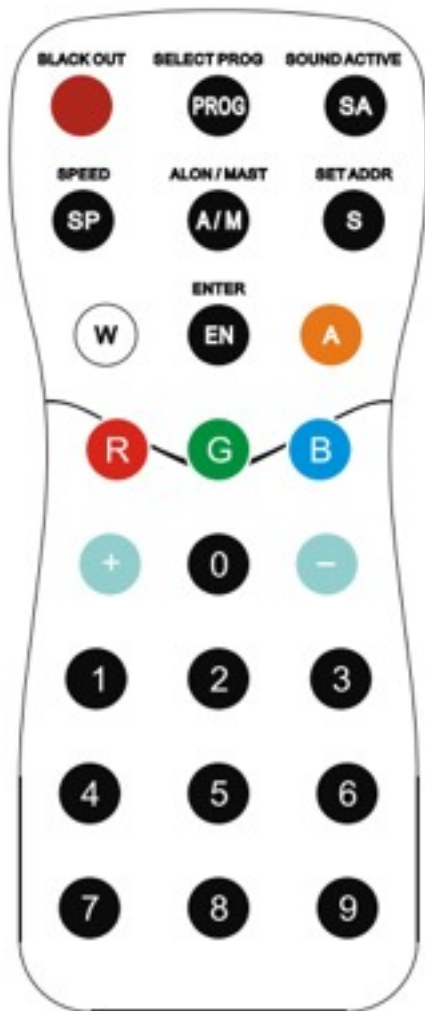

BLACK OUT : The lamp will be turned off after press the button and exit to the status of Address Display.

PROG
AUTO RUN : Press this button to enter the built- in program

SA
SOUND ACTIVE : Press this button to enter the sound active (Please notice that it works only if the lighting fixture has this sound active function)

SP
SPEED : After pressing PROG button, press this button and then you can adjust the speed of programme by pressing “+” or “-“.

A/M
ALON/MAST : Press this button to change the status of Along and Mast.

S
SET ADDR : SET ADDR/DMX MODE. Press this button to change Address. Address can be changed by pressing number key or “+” or “-“ . Then perss ENTER to conserve this address. Meanwhlie, after pressing this button, you can change DMX mode, RED=MODE 1, GREEN =

MODE 2, BLUE= MODE 3, AMBER= MODE 4 , WHITE = MODE 5, by pressing button A,G,B,W,A. (the number of DMX mode depends on the lighting fixture) Then press ENTER to conserve the present mode.

EN
ENTER : Confirm key.

R
R : Press this button to get the full brightness of red color and enter the status of adjustment. Press number+ENTER to dim red color.Press again, the red color will die out.

G
G : Press this button to the full brightness of green color and enter the status of adjustment.,.Press number+ENTER to dim the green color. Press again, the green color will die out.



B : Blue color adjustment button. Press this button to the full brightness of blue color and enter the status of adjustment.,.Press number+ENTER to dim the blue color. Press again, the blue color will die out.



W : Press this button to the full brightness of white color and enter the status of adjustment.,.Press number+ENTER to dim the white color. Press again, the white color will die out. (Please notice that it works only if the lighting fixture has this white color function).



A : Press this button to the full brightness of amber color and enter the status of adjustment.,.Press number+ENTER to dim the amber color. Press again, the amber color will die out. (Please notice that it works only if the lighting fixture has this amber color function).



+ : Press this button to increase the value, long press to increase fast.



— : Press this button to decrease the value, long press to decrease fast.

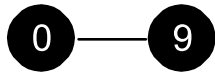

Under different functions, press these number buttons+ENTER can change the address or dimming.

Remark: When press SET ADDR button, if Red LEDs are full on, that means RF controller is available.(If there is DMX signal in, units will be controlled by DMX signal).

14. LENS REPLACEMENT

The DLED STRIP RGBAW comes with a removable front cover that allows the lens assembly to be changed out to achieve different beam angles.

The lens cover is held in place by $\frac{1}{4}$ turn locking fasteners. To remove the cover; 1) Turn the locking fasteners in a counter-clockwise direction. 2) Once the fasteners are loose lift the cover to expose the lens assembly (see illustration below). 3) Remove or replace the filters and reassemble.

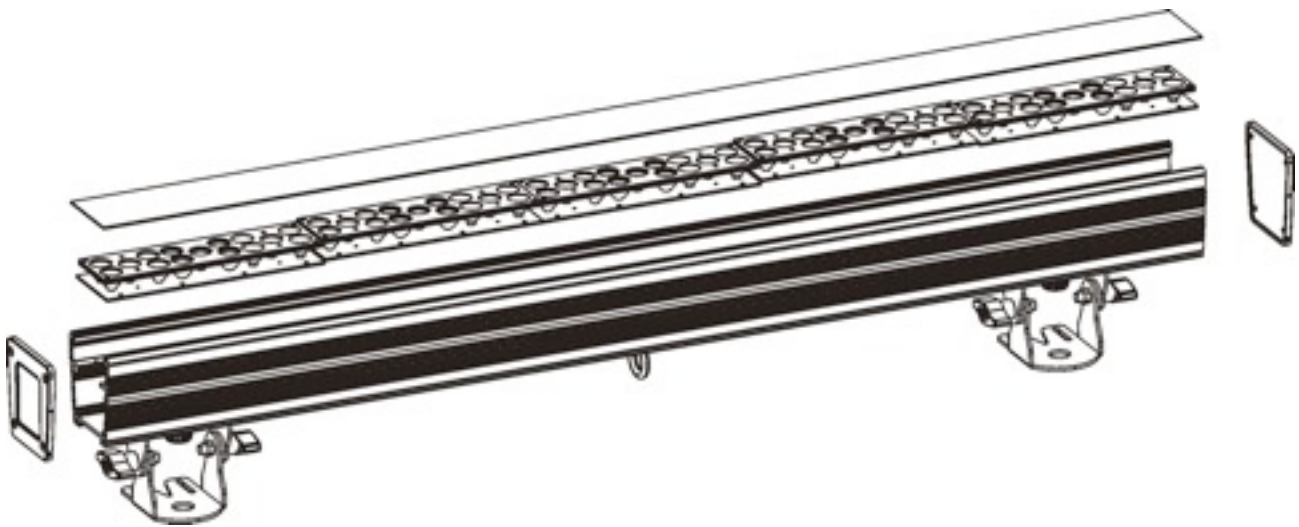

15. CLEANING AND MAINTENANCE

Consider the following points during normal service and inspection:

1. Be sure all screws and fasteners are securely tightened at all times. Lose screws may fall out during normal operation resulting in damage or injury as larger parts could fall.
2. Electric power supply cables must not show any damage, material fatigue or sediments. Never remove the ground prong from the power cable.

Further instructions depending on the installation spot and usage have to be adhered by a skilled installer and any safety problems have to be removed.



CAUTION!

Disconnect from mains before starting maintenance operation.

We recommend a frequent cleaning of the device. Please use a moist, lint- free cloth. Never use alcohol or solvents.

There are no user serviceable parts inside this fixture, please refer all other service issues to an authorized Elation service technician.

Should you need any spare parts, please order genuine parts from your local dealer.

16. 2-YEAR LIMITED WARRANTY

A. Elation Professional® hereby warrants, to the original purchaser, Elation Professional® products to be free of manufacturing defects in material and workmanship for a period of two years, (730 days) from the date of purchase. This warranty shall be valid only if the product is purchased within the United States of America, including possessions and territories. It is the owner's responsibility to establish the date and place of purchase by acceptable evidence, at the time service is sought.

B. For warranty service, send the product only to the Elation Professional® factory. All shipping charges must be pre-paid. If the requested repairs or service (including parts replacement) are within the terms of this warranty, Elation Professional® will pay return shipping charges only to a designated point within the United States. If the entire instrument is sent, it must be shipped in its original package. No accessories should be shipped with the product. If any accessories are shipped with the product, Elation Professional® shall have no liability what so ever for loss of or damage to any such accessories, nor for the safe return thereof.

C. This warranty is void if the serial number has been altered or removed; if the product is modified in any manner which Elation Professional® concludes, after inspection, affects the reliability of the product; if the product has been repaired or serviced by anyone other than the Elation Professional® factory unless prior written authorization was issued to purchaser by Elation Professional®; if the product is damaged because not properly maintained as set forth in the instruction manual.

D. This is not a service contract, and this warranty does not include maintenance, cleaning or periodic check-up. During the period specified above, Elation Professional® will replace defective parts at its expense, and will absorb all expenses for warranty service and repair labor by reason of defects in material or workmanship. The sole responsibility of Elation Professional® under this warranty shall be limited to the repair of the product, or replacement thereof, including parts, at the sole discretion of Elation Professional®. All

products covered by this warranty were manufactured after January 1, 1990, and bare identifying marks to that effect.

E. Elation Professional® reserves the right to make changes in design and/or improvements upon its products without any obligation to include these changes in any products theretofore manufactured.

F. No warranty, whether expressed or implied, is given or made with respect to any accessory supplied with products described above. Except to the extent prohibited by applicable law, all implied warranties made by Elation Professional® in connection with this product, including warranties of merchantability or fitness, are limited in duration to the warranty period set forth above. And no warranties, whether expressed or implied, including warranties of merchantability or fitness, shall apply to this product after said period has expired. The consumer's and or Dealer's sole remedy shall be such repair or replacement as is expressly provided above; and under no circumstances shall Elation Professional® be liable for any loss or damage, direct or consequential, arising out of the use of, or inability to use, this product.

G. This warranty is the only written warranty applicable to Elation Professional® Products and supersedes all prior warranties and written descriptions of warranty terms and conditions heretofore published.

17. PHOTOMETRIC DATA

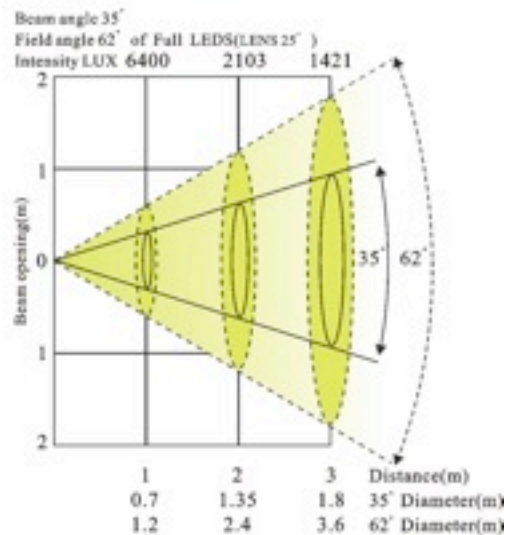
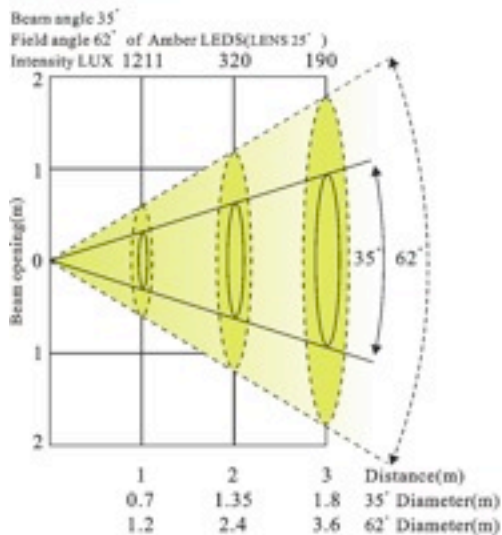
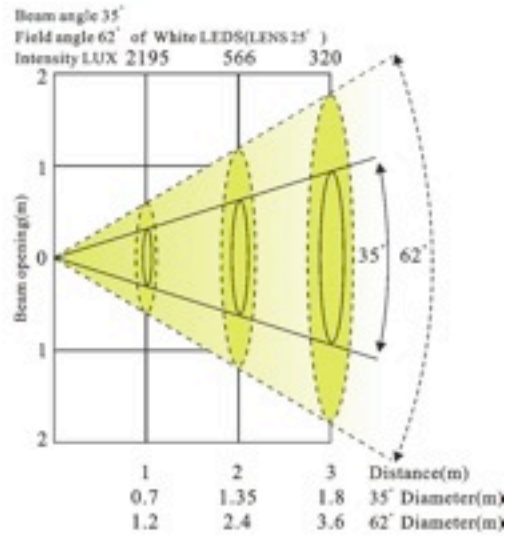
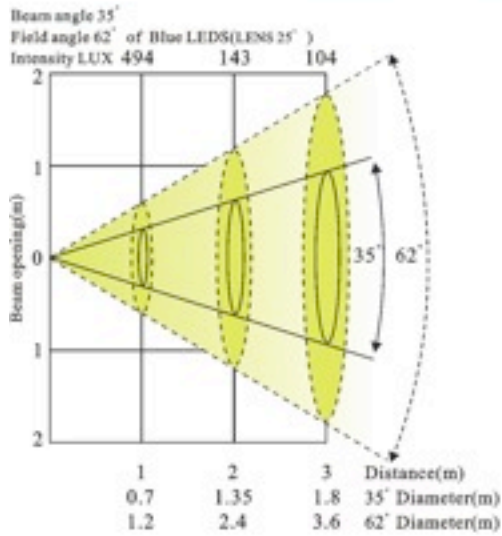
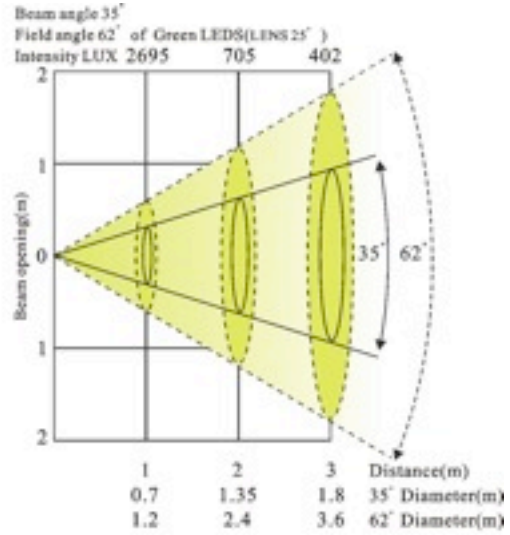
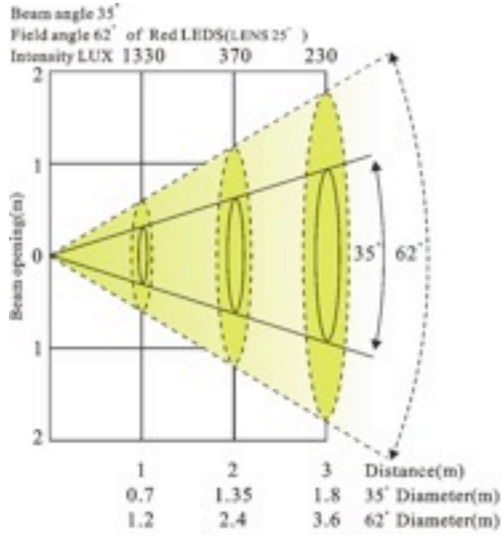

18. DIMENSIONAL DRAWINGS

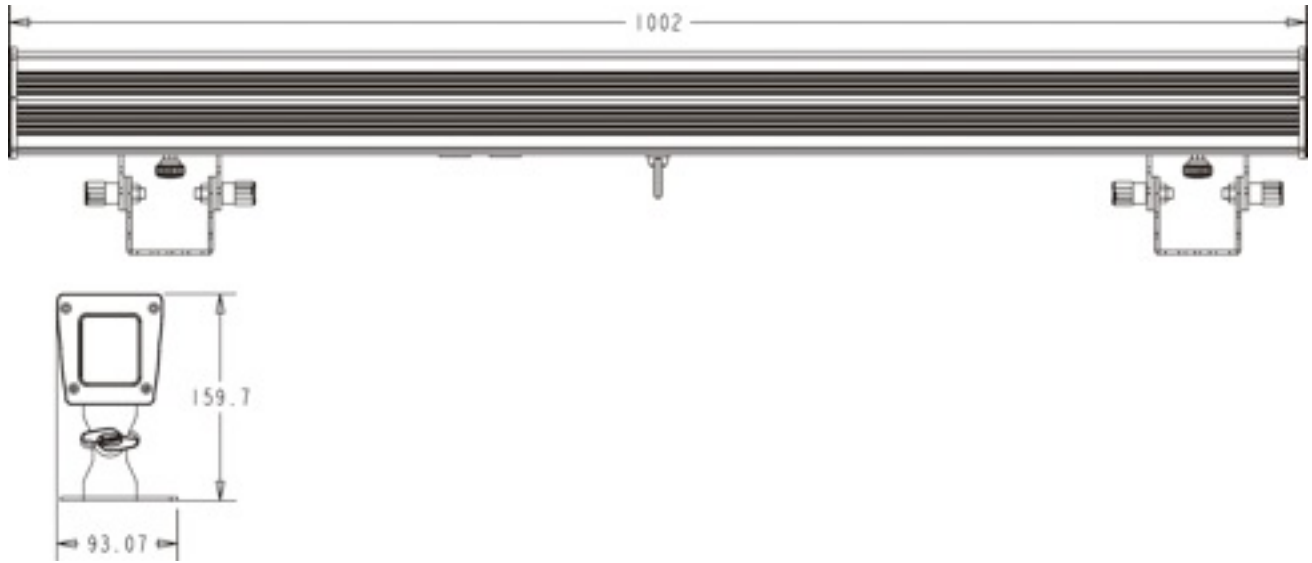

19. CIRCUIT SCHEMATIC

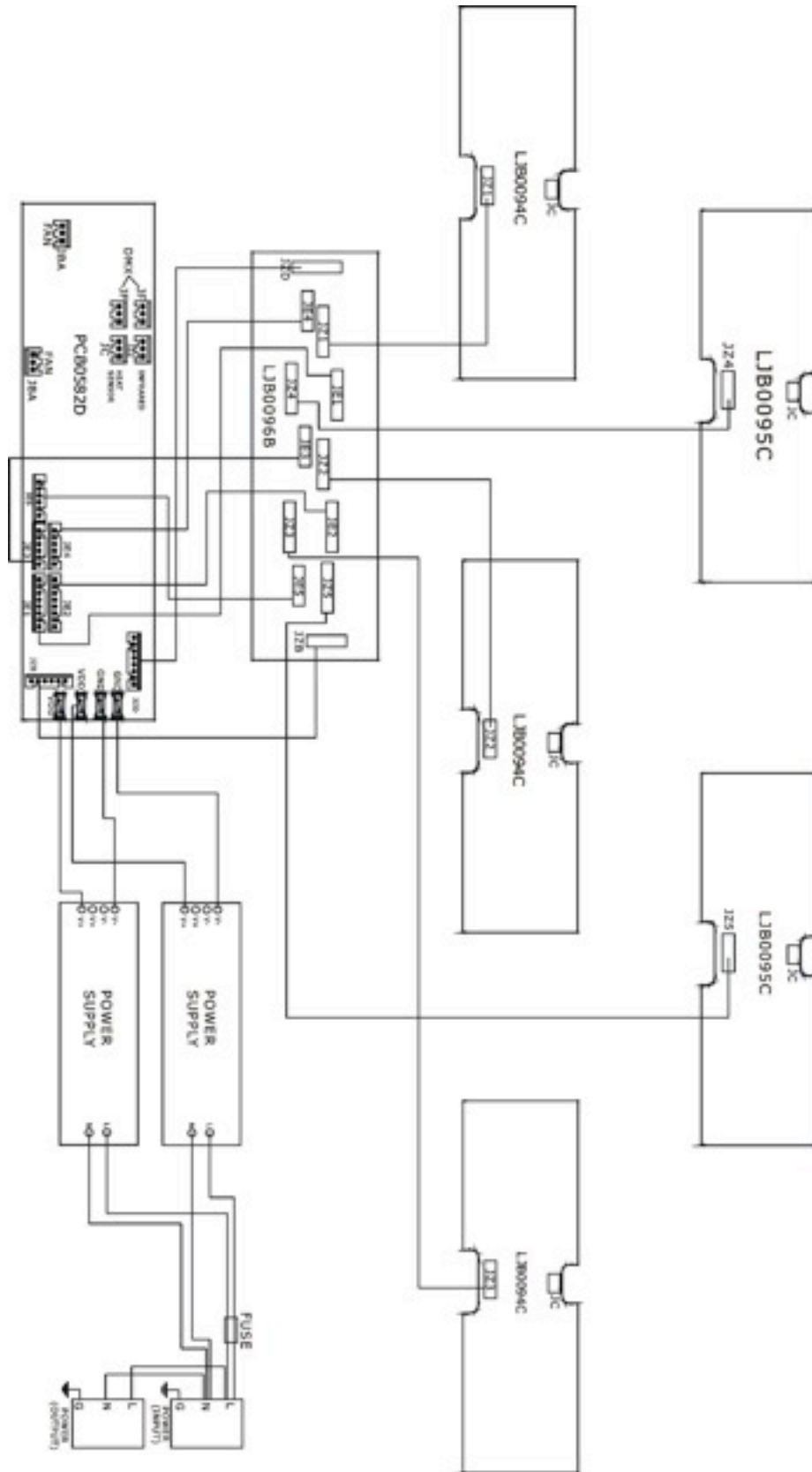

20. TECHNICAL SPECIFICATIONS

| | |
|---------------------------|---|
| <i>Power supply:</i> | <i>AC 100V-240V~, 50Hz/60Hz</i> |
| <i>Power consumption:</i> | <i>Maximum 100W</i> |
| <i>LED Configuration:</i> | <i>75 x 1 Watt</i> <i>(15 x Red, 15 x Green, 15 x Blue, 15 x White, 15 x Amber)</i> |
| <i>Weight:</i> | <i>27.5 Kgs / 60.6Lbs</i> |
| <i>DMX Channels:</i> | <i>28, 25, 9, 6, or 5 (default) Channel mode</i> |
| <i>DMX Drive:</i> | <i>Standard DMX-512,</i> <i>3 pole IP Rated Locking Connector; [+] = Pin 3 [-] = Pin 2</i> <i>[Ground] = Pin 1.</i> |
| <i>Color Mixing:</i> | <i>RGBWA Color Additive Mixing</i> |
| <i>Beam Angle:</i> | <i>35° Beam Angle/62° Field Angle (25° Lens)</i> |
| <i>Fuse:</i> | <i>GMA 250v~3.15A (Internal)</i> |
| <i>Dimmer:</i> | <i>Continuous Dimming 0~100%</i> |
| <i>Strobe:</i> | <i>Electronic Strobe 0~18 Fps</i> |
| <i>Lamp Life:</i> | <i>100,000 Hours Rated Life</i> |
| <i>Dimensions:</i> | <i>(1002 x 93.07 x159.7) mm</i> <i>34.4" x 3.7" x 6.29"</i> |

Please Note: Specifications and improvements in the design of this unit and this manual are subject to change without any prior written notice.

Elation Professional
6122 S. Eastern Ave.
Los Angeles, CA. 90040
323-582-3322 / 323-832-9142 fax
www.ElationLighting.com / Info@ElationLighting.com